

RUD CONVEYOR SYSTEMS

FOR HORIZONTAL, VERTICAL AND INCLINED CONVEYORS

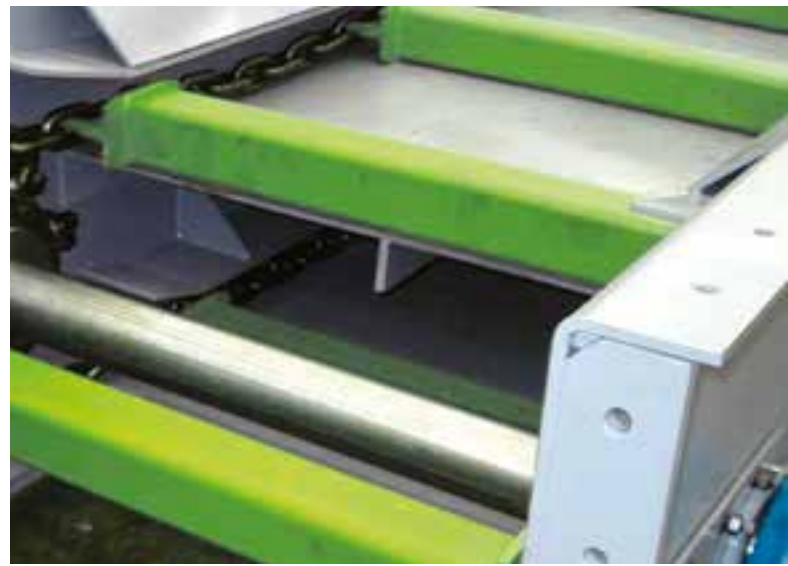

DO YOU EXPERIENCE ANY OF THESE CONVEYOR ISSUES



Is your chain equipment wearing out too quickly?

The new RUD chain grades offer optimal wear resistance. **More on page 10**



Are your chains or the teeth of the gears suddenly breaking? Is your system coming to a standstill due to this? How much is the damage if you have to shut down the system as a result of this?

The new chain grades offer up to 28% improvement in breaking force. Your system will run safer and the risk of breaking will be minimised. **More on page 11**



Are you experiencing difficulties when installing components?

Then try our installation-friendly innovations such as **Duomount** or **2win**. **More on page 26 und 42**



Are you missing an on-site contact person?

Then contact our nearest branch. **More at www.rud.com (units & locations)**



Do you wish for more technical consultation and assistance?

Then simply ask us. directly contact our engineers and send us your challenges related to the conveyor system. **conveyor@rud.com // Technical questionnaires from page 64**

Can you imagine what it would be like to work together with a company that is competent to solve all your challenges related to the conveyor system and moreover guarantees a high level of service and commercial support?

Then contact us at the german headquarters: conveyor@rud.com // Tel.: 49 (0)7361 5041457 // Fax: +49 (0)7361 5041523



RUD CRATOS Service range and milestones	04
RUD BULKOS milestones for conveyor systems	06
RUD conveyor chain systems	
Conveyor systems for horizontal conveyance	08
Conveyor systems for vertical conveyance	09
RUD chain technology	
New special products	10
Our strengths at a glance	11
round steel chain - hardbess profile	12
The new round steel chain R160	13
Round link steel chains –new RUD specifications at a glance	14
Chain connector RSP, FL, VK	16
System sprocket wheels	
Sprocket wheels	
Multi-part	18
Single-part	19
Our Tip: Tooth segments with increased pitch circle diameter	20
Structure pocket wheel multi-part	20
Reversing wheels: Typ A, B and C	21
Submerged overhung idler (SOI)	22
Attachment-System sprocket wheel	
Attachment	
FM	24
MEZ-Z	25
F	25
DUOMOUNT	26
SSR	26
SSRF	27
Scrapers	
Safer scraper operation with paired RUD chain strands	28
Scrapers – individual specifications	29
Usage examples for RUD scraper	29
Use areas	30
System pocket wheel	
Pocket wheel	
Multi-part	32
Single-part	33
Attachments	
MEE-T	34
MEZ-T	35
Bucket attachments	
Bucket attachments at a glance	36
Description chain elevators	38
System RUca, 2win, SWA	
RUca backwall bucket attachment	40
2WIN backwall bucket attachment	42
SWA site wall bucket attachment	43
Chain wheel for bucket elevators	44
SYSTEM 65	
Bucket attachment SYSTEM 65	45
Reversing wheel	46
Sprocket wheel	47
Central chain	
RU50, RU80, RU150 and RU200	48
Drive wheel	51
Drive wheel, tension sprocket	51
Belt type bucket elevator	52
Trough chain conveyor	56
FORKY forked chains	
Single & double strand	58
Attachment, components, wheels, sprockets	59
Trough chain conveyor with forked chain FORKY	60
Screw conveyor	62
General instructions for installation and operation	64
Dimension sheets / questionnaires	66
Conveyor and drives (sectional overview)	75



RUD SERVICE RANGE AND MILESTONES

RUD CONVEYOR TECHNOLOGY IN THE POWER STATION

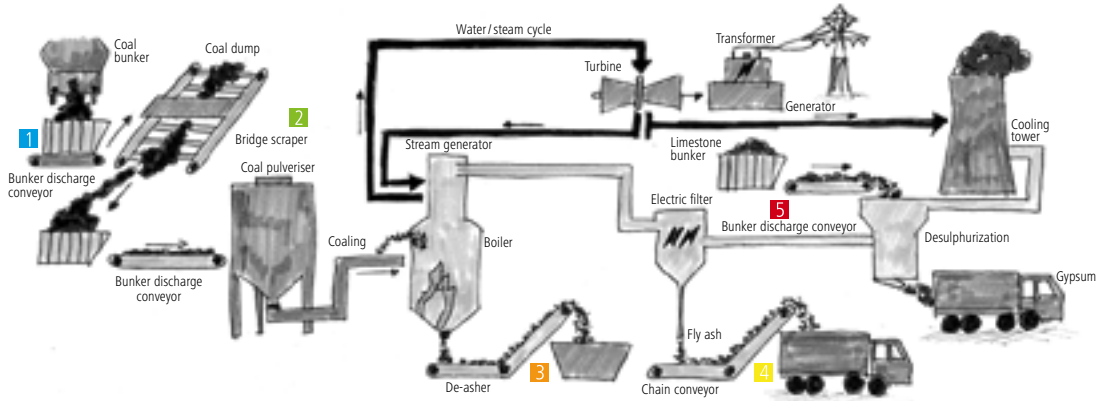

- 1** Bunker discharge
- 2** Bridge scraper
- 3** De-asher
- 4** Chain conveyor
- 5** Components

Fossil power stations will also become an important contribution towards global supply of energy. For decades, RUD has been ensuring a high availability of coaling and ash remover plants with the help of its conveyor chains and hence ensures power generation in power stations. Thanks to our extensive experience in ash removal of large power plant boilers, biomass combustion as well as waste incineration and recycling, all our system components are always perfectly coordinated and always work reliably.



- 1875 RUD as the foundation of ERLAU AG
- 1951 First RUD global casehardened round link steel chain
- 1957 First RUD chain for de-ashing
- 1965 First round link steel chain in RUD 40 cG material
- 1985 First round link steel chain with RUD super 35 quality
- 1992 First RUD apron conveyor
- 2006 Attachment DUOMOUNT
- 2007 RUD forked link chain FORKY
- 2008 First dry ash remover with RUD chains
- 2010 Brand RUD CRATOS
- 2012 First biogassubstrate feeder
- 2015 Conveyor chain R160

OUR REFERENCES IN THE POWER STATION

Among others, we are system partners of:





MILESTONES FOR CONVEYOR SYSTEM FOR BULK MATERIALS

TOGETHER FOR OVER 200 YEARS OF COMPETENCE

Whether it is a complete bucket conveyor, trough chain conveyor or spare parts for chain conveyors or maintenance and service, the RUD group is a reliable partner. Let it be transporting limestone from the mill to the bulk tank or conveying salts from the mine to the surface, our conveyor systems are robust and are optimally designed for these conditions. Thanks to our extensive experience in bulk conveyance of fertilisers, potassium & salt, cement and other special bulk materials, all our system components always work reliably.



- 1875** Foundation of RUD Ketten Rieger & Dietz GmbH u. Co. KG
- 1906** As the first company, RUD introduces electric welding of chain links
- 1945** Foundation of business area of conveyor systems by Werner Rieger
- 1961** Introduction of double-pitch case-hardened round link steel chains for high-capacity bucket elevators
- 1965** Introduction of round link steel chain in 40cG material / market introduction of two-link bucket attachment system 65
- 1985** Round link steel chain with RUD super 35 quality
- 1992** RUD apron conveyor
- 1994** RUD central chain installed in high-capacity bucket elevators
- 2001** Market introduction of RUD SWA side-wall attachment
- 2004** Integration of H & E in RUD group
- 2006** Market introduction of RUD 2win two-link bucket attachment
- 2007** RUD forked link chain FORKY
- 2008** Central chain bucket elevator for 800 t/h
- 2009** First trough chain conveyor with RUD forked link chain FORKY
- 2011** 1st tandem central chain bucket elevator for 1500 t/h
- 2011** Introduction of brand name BULKOS
- 2015** Conveyor chain R160
- 2017** **Market introduction RUD RUca single-link attachment short assembly and disassembly times, without special tools**



MILESTONE OF H + E HERFURTH & ENGELKE CONVEYOR SYSTEM TECHNOLOGY

Braunschweig / Germany

- 1932** Foundation of engineering office for conveyor systems
- 1933** Creation of 1st continuous flow conveyor for bulk materials
- 1940** Beginning of own production of 1st chain bucket elevator, 1st screw conveyor, 1st apron conveyor
- 1945** Foundation of machine factory Herfurth & Engelke
- 1960** 1st belt bucket elevator
- 1969** 1st chain bucket elevator for 300 t/h
- 1970** 1st trough chain conveyor for 600 t/h
- 1972** Transport of 1000 t/h (band conveyor)
- 1973** 1st screw conveyor for 300 t/h
- 1981** 1st vertical screw conveyor
- 1985** Development of high-capacity bucket elevator, 1st usage of steel cord belt in bucket elevators
- 1988** Development of parallel weight tensioning station for bucket elevators, transport of 3000 t/h (band conveyor)
- 1998** 1st central chain bucket elevator, 1st chain bucket elevator for 1100 t/h
- 2001** 1st central chain bucket elevator for 600 t/h











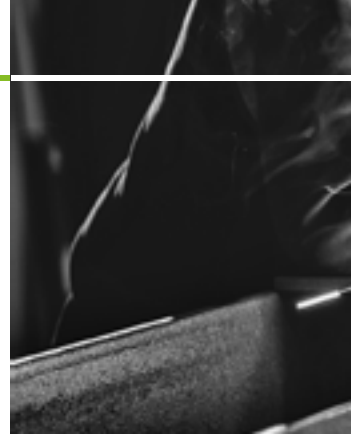













1. CHAIN PRODUCTION
2. MILLING
3. HEAT TREATMENT
4. MACHINE CONSTRUCTION

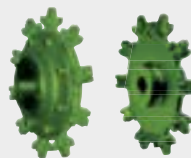

OUR RUD CONVEYOR CHAIN SYSTEMS

AT A GLANCE

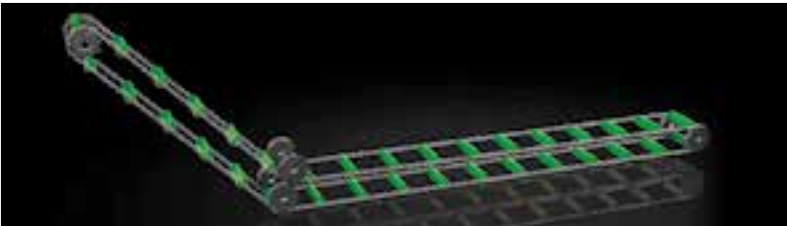
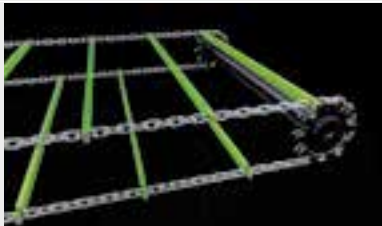

		HORIZONTAL CONVEYOR 							
RUD-System	 Sprocket wheel system	 System pocket wheel							
Chain	 Size 8 × 31 ... 38 × 144, material R80, R100, R140, R160								
Connectors	 FL 22 × 86 ... 38 × 144	 RSP 8 × 31 ... 19 × 75	 VK 8 × 31 ... 34 × 136	 FL 22 × 86 ... 38 × 144 RSP 8 × 31 ... 19 × 75					
Attachment type	Multiple link attachment		Single link attachment						
Attachments	 BLUMMONT 26 × 100 ...	 SSRF 14 × 50 ... 38 × 144	 SSR 10 × 38 ... 30 × 120	 F 18 × 64 ... 22 × 86	 MEZZ 10 × 31 ... 38 × 144	 FM 8 × 31 ... 30 × 120	 MEET(K) 10 × 38 ... 38 × 144	 F 18 × 64 ... 22 × 86	 MEZT 10 × 38 ... 30 × 120
Drive wheels	Drive sprocket (internal) interlocked. 		Above size 14 × 50 mostly multi-part, locks always run vertically across the gears 						
Reversing wheels	 Type A with rim often at the tensioning station and as SOI, type B without rim for all the remaining deflections, rarely single gearwheels		 Type C for attachment mezz and FL, alternative is single gearwheels		 Drive pocket wheels (external) interlocked, mostly multi-part at the drive, rarely single, locks always run vertically as well as horizontally across the gears; preferred installation type vertical. Reversing wheels – very often also pocket wheels, rarely pulley blocks of type B for attachment F and type C for MEET(K) or MEZT.				
Applications									
Remark	The sprocket wheel system is advantageous for conveyors that have an angled line profile (several times) (reversing wheels help this type of conveyors in association with the attachment) and have a sharp increase (>20°). Scraper height depending on the chain width, material to be transported and the gradient of the conveyor as well as the conveyance capacity must be calculated. Usual conveyance speed of 0.02 m/s to approximately 0.15 m/s depending on the service life to be projected. Typical example: de-ashing systems in power stations.		Universally applicable as cleaning scraper conveyor, bunker discharge conveyor (multi-belt conveyor) as well as apron conveyor. Usual speed of 0.05 m/s to 0.2 m/s depending on the material to be transported. Straight line profile preferred, slightly inclined (up to 20°) installations possible. Scraper height normally not greater than $0H = 1.5 \times b_s$.						



VERTICAL CONVEYOR



System 65

NEW

2win System / RUca

NEW

SWA System

Central chain System



Size 14 × 50 ... 34 × 126, material R80, R100, (R140)

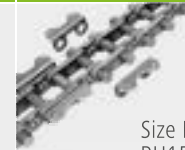

Size RU50, RU80, RU150, RU200



VK 14 × 50 ... 34 × 136



RSP 14 × 50 ... 19 × 75



FL 22 × 86 ... 34 × 136

Coupling strand; rarely necessary, if the tensioning distance is long enough

Multiple link mounting

Mounting angle



System 65 14 × 50 ... 34 × 136



2win 14 × 50 ... 34 × 136



RUca 16 × 64 ... 26 × 100



SWA 16 × 64 ... 30 × 120



Is a separate component of the chain



Driving wheel toothed with individual teeth



Driving wheel not toothed, hardened segments, toothed drive such as in system 65 even in difficult applications



Drive wheel toothed with individual teeth, rarely not toothed



Drive not toothed, hardened



Reversing section always used with smooth sprocket, unhardened segments and flanged wheel



Reversing section always used with grooved sprocket, unhardened segments, special cases and with flanged wheel



Reversing section always used with grooved sprocket, unhardened segments and constriction wheel with hardened segments



Reversing section toothed (from 800 bucket width) / without teeth (up to 710 bucket width), hardened



2WIN



RUca

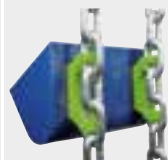

Central chain bucket elevators for large conveyance capacities, coarse dry bulk materials (clinker, gravel, circulating goods and cement granules) and high speed (up to 1.7 m/s); steel chain bucket elevators.

System 65 for sticky, coarse-grained bulk materials, when using high-capacity bucket conveyors and speed 1.35 ... 1.5 m/s.

2win-System for DIN bucket elevators (DIN bucket without gear teeth, hl and special bucket toothed), low granulation (up to 40 mm without gear teeth, toothed after that), speed of 1.0 ... 1.4 m/s;

SWA System for small conveyance capacities and low speed (...0.8 m/s), highly abrasive materials to be transported that are difficult to empty (central discharge with technical consultation).



RUD CHAIN TECHNOLOGY

NEW SPECIAL PRODUCTS – WHAT HAS IMPROVED IN OUR NEW CHAIN GRADES?

1

100 % CONSISTENTLY INDUCTIVELY HEATED RODS



This results in: Accurate link geometry · Highly calibrated links
Customer benefit: · Optimised running geometry with components and wheels · Better interlink contact to extend chain life

2

100 % FULLY AUTOMATIC WELDING CONTROLLER WITH PRECISE LINK



This results in: Optimal process control
Customer benefit: Longer life · Increased breaking force · Safer operation

RUD is benchmark company in providing quality products with advantages in wear resistance and performance ahead of all competing companies.

3

100 % FULLY AUTOMATIC CONTROL AND REGULATION OF CALIBRATION



This results in: Highly calibrated chain strands · More accurate chain properties for multi-strand applications
Customer benefit: Optimised run-in behaviour · Lower wear · Lower maintenance costs

4

100% WORLD FIRST! RUD CONVEYOR CHAIN R160 MADE OF SPECIALLY SMELTED SPECIAL STEEL



This results in: New options in heat treatment
Customer benefit: Improved wear characteristics in case of equal breaking force

BENEFIT FROM OUR HIGH PERFORMANCE

Performance		RUD [®] Special grades				
Property	RUD [®]	R80	R100	R140	R160	
Wear	Carburising depths in the link after macro etching (HTA) (... × d)	0.10	0.10	0.14	≥ 0.16	
	Surface hardness in the link (HV)	800	820	≥ 820	≥ 820	
	System components (compatible with each other)	+++	+++	+++	+++	
Operational safety	100 % calibrated / reproducibility	+++	+++	+++	+++	
	Special fused metal for chain steel with special alloy proportions	+	++	++	+++	
	Crack retention capacity	+	+++	+++	+++	
Simple assembly / traceability	Matching	+++	+++	+++	+++	
	Labelling on every component and chain link	+++	+++	+++	+++	
	Labelling of suitable pair using colours	+++	+++	+++	+++	
Downsizing	Tensile stress up to N/mm ²	340	450	400	400	

RUD ROUND LINK STEEL CHAINS

THE NEW RUD SPECIFICATIONS, HARDNESS CURVES

HIGH QUALITY
MADE IN GERMANY

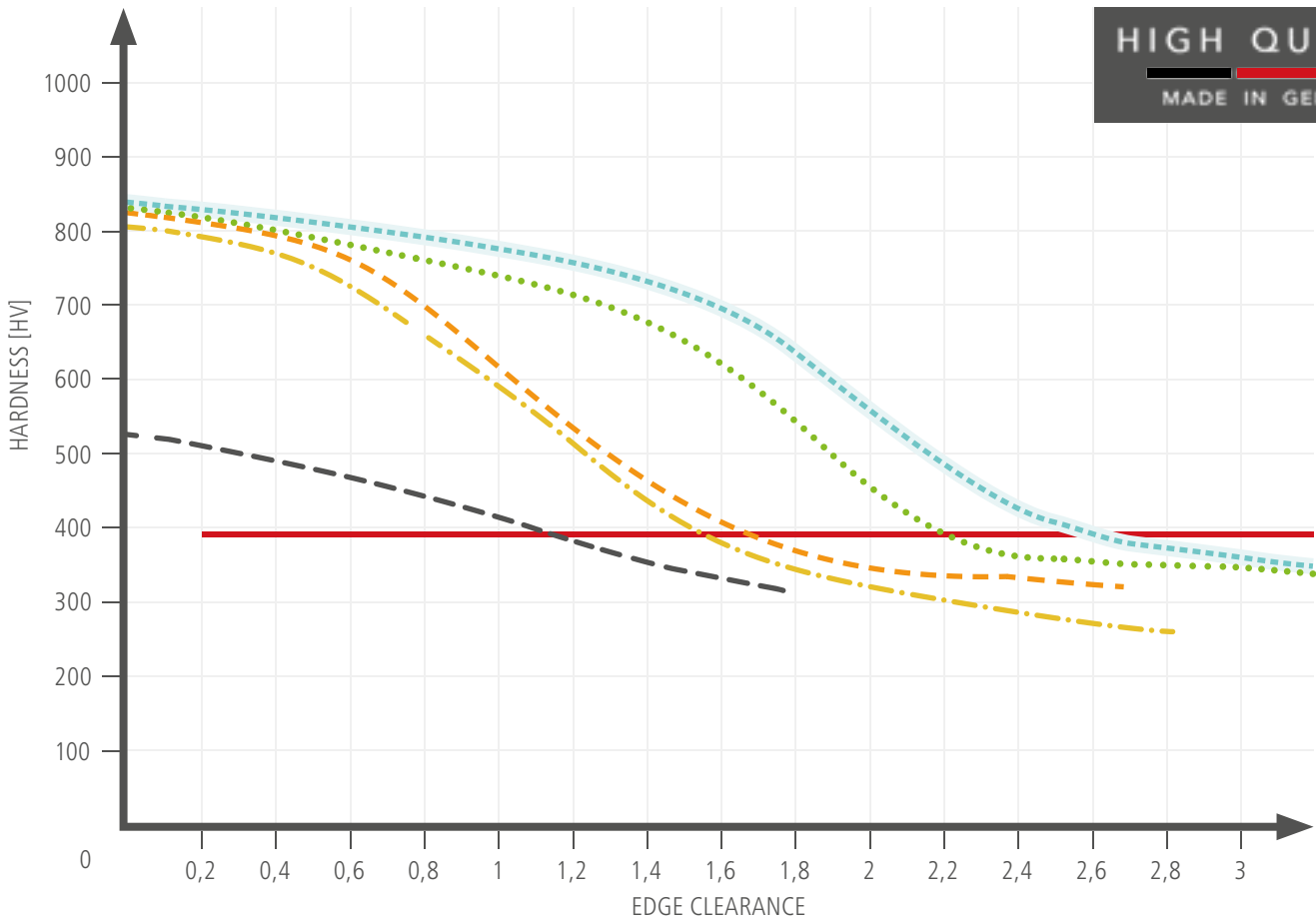

..... Case hardened Chains R160
 Case hardened Chains R140
 - - - - Case hardened Chains R100
 - . - . Case hardened Chains R80
 - - - - Case hardened Chains R2B
 ———— quenched and tempered chains R2

HARDNESS PROFILE ACROSS THE CROSS-SECTION

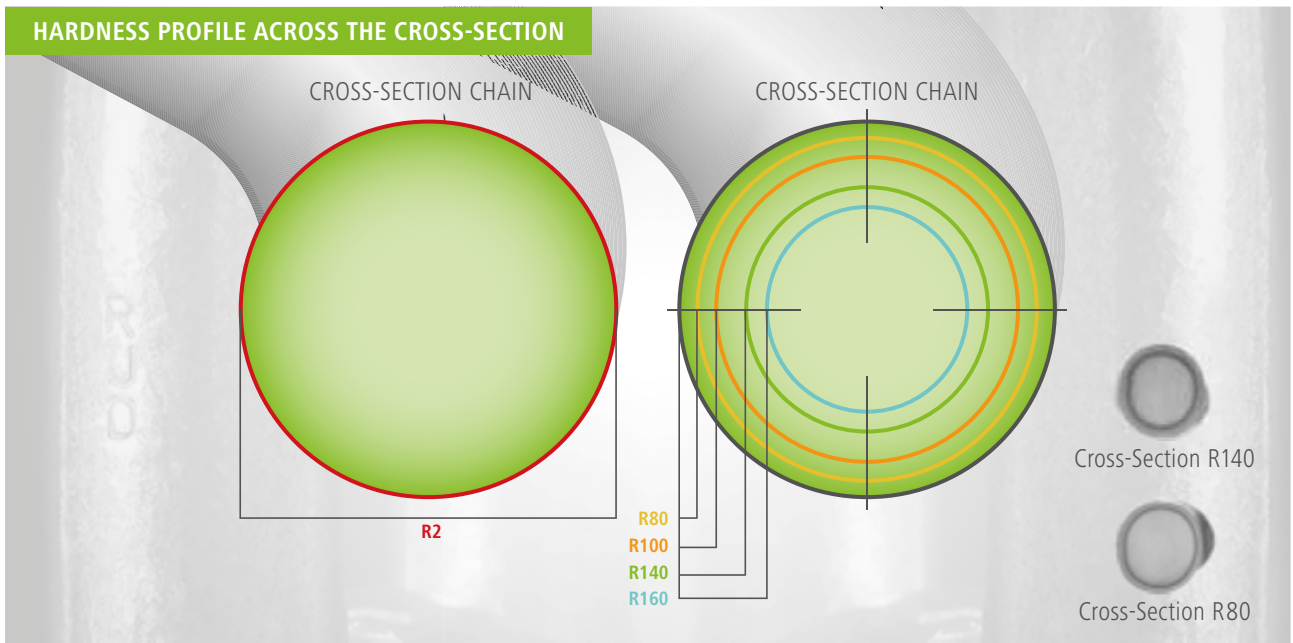

RUD ROUND STEEL CHAIN R160

TOUGH AND 30% MORE RUNNING TIME

NEW

RUD offers its customers nothing less than double the service life in the use of bucket elevators and ash removal systems – the new round steel chain R160 has been optimised with regard to a longer service life.

Our special chain steel improves the wear behavior significantly without any loss of breaking force. Its breaking stress of up to 400 N/mm² provides especially for particularly rough and heavy duty operating conditions (e.g. in coal fired powerplants) a better performance in relation to other chain grades and therefore an increase of the revision time frame up to two times. The operating time of the whole facility will be significantly increased.

The R160 is currently available in the following sizes:

- 19 x 75 mm · 30 x 120 mm
- 22 x 86 mm · 34 x 136 mm
- 26 x 100 mm · 38 x 144 mm

The RUD R160 offers improved technical features that contribute to higher economic efficiency and operational safety. In combination with other products in the portfolio, RUD offers its customers the most innovative tailor-made solutions.

MORE THAN YOU EXPECT - FULL operation IN rough CONDITIONS



**30%
more are not enough!**

MANURE

CEMENT

GRAVEL

COAL



„RUD stands for innovation and quality. With the R160, RUD’s think tank launched a product on the market that can clearly extend the service life of our bucket elevator. The R160 acquisition costs were certainly higher, but considering the TCO (Total Cost of

Ownership), the investment has definitely been worth it. All plant owners will certainly be keen to increase their production capacity levels while reducing costs at the same time. This goal can indeed be achieved with the R160.“

Robert Ott
Head of Maintenance

 **LafargeHolcim**
www.lafargeholcim.com

RUD ROUND STEEL CHAIN

THE NEW RUD SPECIFICATION

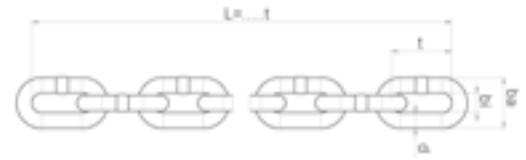

ROUND STEEL LINK CHAINS IN SPECIAL GRADES – HIGHLY WEAR-RESISTANT

Chain d × t in mm	Chain width		Weight [kg / m (lb/yd)]	Strand length [m (yd) / Link* ⁽¹⁾]	Attachment distance [Links]
	bi (min.) [mm]	ba (max.) [mm]			
8 × 31	10.3	28	1.3 (0.95)	50.0 (164.04) / 1613	variable
				Fitting strand	
				24.893 (81.67) / 803	
10 × 38	12.5	34	2.1 (1.54)	50.0 (164.04) / 1315	variable
				Fitting strand	
				20.026 (65.70) / 527	
14 × 50	16.3	47	4.0 (2.94)	19.95 (65.45) / 399	variable
				Fitting strand	
14 × 64	16.3	47	3.7 (2.95)	10.176 (33.38) / 159	variable
				Fitting strand	
16 × 64	20	55	5.1 (3.77)	38.336 (125.77) / 599	variable
				19.9 (65.29) / 311	
				Fitting strand	
18 × 64	21	60	6.9 (5.10)	28.224 (92.6) / 441	variable
				15.296 (50.18) / 239	
				Fitting strand	
19 × 75	22	63	7.7 (5.67)	53.925 (176.92) / 719	variable
				10.725 (35.19) / 143	
				Fitting strand	
19 × 120	23	65	6.3 (4.63)	3.0 (9.84) / 25	2
				5.16 (16.93) / 43	
				Fitting strand	
22 × 86 ⁽⁵⁾	26	74 (73)	9.7 (9.5) (7.13 (6.98))	10.234 (33.58) / 119	variable
				Fitting strand	
25 × 95	34	90	12.5 (9.2)	8.265 (27.12) / 87	4
				Fitting strand	
26 × 92	30	85	13.7 (10.07)	14.444 (47.39) / 157	variable
				Fitting strand	
26 × 100	31	87	13.3 (9.78)	7.9 (25.92) / 79	4 / 8 / 10 / 16
				8.1 (26.57) / 81	nx4+1x6
				8.3 (27.23) / 83	4 / 6 / 12 / 14
				Fitting strand	–
30 × 108	34	97	18.0 (13.23)	10.692 (35.08) / 99	variable
				Fitting strand	
30 × 120	36	102	17.5 (12.87)	5.640 (18.50) / 47	4 / 6 / 8 / 12 / 16
				5.88 (19.29) / 49	10
				Fitting strand	–
34 × 126	38	109	22.7 (16.7)	8.694 (28.52) / 69	variable
				Fitting strand	
34 × 136	39	113	23.8 (17.49)	4.760 (15.62) / 35	4 / 6 / 12 / 18
				5.304 (11.69) / 39	4 / 8 / 10
				Fitting strand	–
38 × 144	44	127	30.0 (22.07)	3.312 (7.30) / 23	8 / 12
				4.176 (9.21) / 29	4 / 6 / 10
				Fitting strand	–

Properties

- Highly wear-resistant for a long time
- High-strength, as optimally heat-treated
- Self-cleaning
- Low-maintenance when compared to other systems
- Simple assembly and disassembly of RUD components in the chain belt

Ordering example

Chain for bulk material R100
 Dimension 19 × 75
 Number in strands 10
 Looped chain length 20 m
 Type of conveyor Double strand

ROUND STEEL LINK CHAINS IN SPECIAL GRADES – HIGHLY WEAR-RESISTANT*3)

R2		R2B		R80		R100		R140		R160		Chain d × t in mm
Breaking Force [kN (lbf)]	RUD Part number	Breaking Force [kN (lbf)]	RUD Part number	Breaking Force [kN (lbf)]	RUD Part number	Breaking Force [kN (lbf)]	RUD Part number	Breaking Force [kN (lbf)]	RUD Part number	Breaking Force [kN (lbf)]	RUD Part number	
80 (17,984)	51697											8 × 31
	7983021											
125 (28,101)	7987062											10 × 38
	7983022											
250 (56,202)	8504309*2)											14 × 50
												14 × 64
		240 (53,954)	7988920 7989510	100 (22,4781)	7902367	180 (40,466)	7905640 7905641					16 × 64
					7902366							
				125 (28,101)	7908982		7905643 7905644					18 × 64
					7908983							
		340 (76,435)	7904795 7904540	140 (31,473)	7902205	260 (58,450)	7905646 7905648	230 (51,706)	7905862 7905863	230 (51,706)	7909280 7909283	19 × 75
					7909075							
												19 × 120
610 (137,133)	8504310*2)	450 (101,164)	7101774	260 (58,450)	7905474	350 (78,683)	7905654 7905655				310 (69,691)	7905719
					7905475							7905720
						400 (89,924)	7905657 7905658					22 × 86 *5)
850 (191,087)	7906999*2)			370 (83,179)	7905480							26 × 92
					7905477							
												26 × 100
				370 (83,179)	7905491	430 (96,668)	7905660 7905661 7905662	370 (83,179)	7909277 7909278	430 (96,668)	7905722 7905723 7905724	26 × 100
		7905492 7905493										
1130 (254,034)	7907002*2)			440 (98,916)	7905497							30 × 108
					7905496							
				440 (98,916)	7905498	640 (143,878)	7905664 7905666 7905667			580 (130,389)	7905727 7905728 7905729	30 × 120
		7905499 7905500										
1450 (325,973)	7907005*2)			460 (103,412)	7905502	720 (161,862)	7905670 7905672					34 × 126
					7905503							
				460 (103,412)	7905521	720 (161,862)	7905675 7905676 7905678	630 (141,630)	7905865 7905866 7905868	670 (150,622)	7908694 7908692 7908695	34 × 136
		7905522 7905506										
												38 × 144
						920 (206,824)	7905680 7905681 7905683			850	7908697 7908698 7908699	38 × 144

*1) Maximal variable length: no longer than the standard belt length (in bold print)

*2) Length in compliance with ordering specifications

*3) Allowed tolerance of breaking tension +/- 10%

*4) RUD materials R40c-G/s3

*5) Bracketed values for chain material R2



RUD CHAIN CONNECTORS

RSP // CONNECTING LINK



CHAIN CONNECTOR RSP (SPACE-SAVING)

Properties

- For using in single and multi-strand conveyors
- For medium operating conditions
- Highly wear-resistant
- Installation dimension corresponding to chain link dimension
- Run over sprocket wheels, grooved wheels and flat wheels - vertical
- Run over pocket wheels vertical;
In special cases horizontal run possible – see picture underneath

RUD Part no.	Chain d × t in mm	A	B	C	E	kg / Piece
58571*	8 × 31	22	29	10	M 5	0.05
54959*	10 × 38	27	35	12	M 6	0.1
53900	14 × 50	38	48	17	M 8	0.25
53977	14 × 64	38	48	17	M 8	0.3
57947	16 × 64	43	56	18.5	M 10	0.5
52694	18 × 64	43	56	18.5	M 10	0.5
55196	19 × 75	51	66.5	23	M 12	0.8

* Zinc-coated

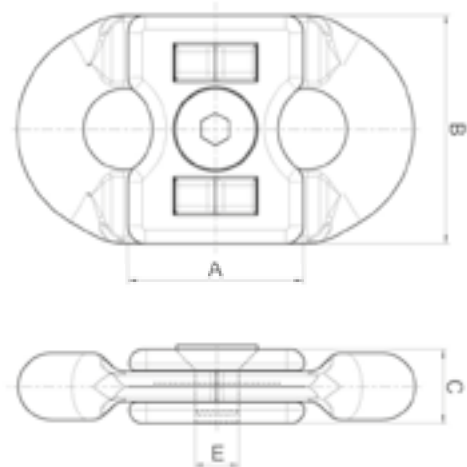
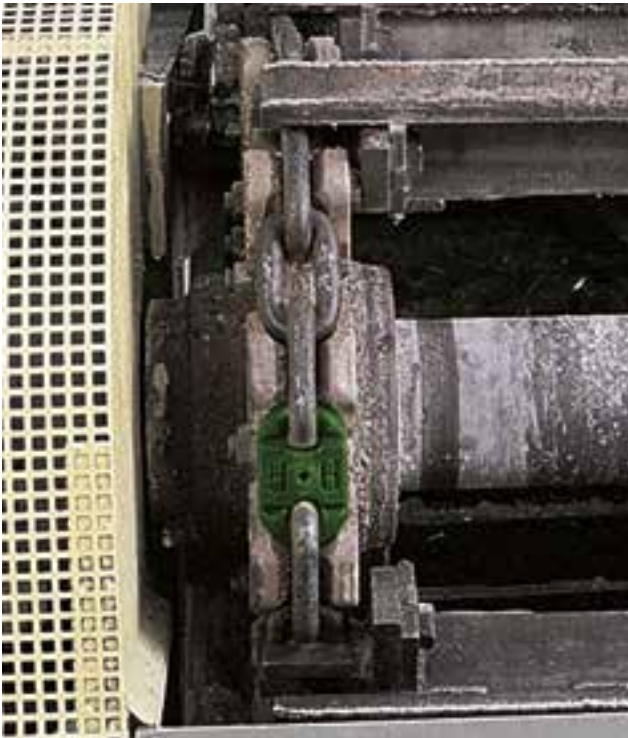

CONNECTING LINK FOR CHAIN GRADE R2

Runs preferably vertical over pocket wheels

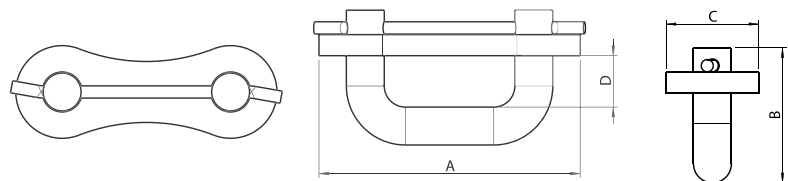

RUD Part no.	Breaking force [kN]	For chain d × t in mm	A	B	C	E	kg / Piece
7986777	80	8 × 31	62	32	22	12	0.08
58594	125	10 × 38	77	36	28	13	0.14
7987640 / 8500097	246	14 × 50	96	46	32	17	0.8 / 0.9

RUD CHAIN CONNECTORS

FL // VK



FLAT CONNECTOR FL

Properties

- For using in single and multi-strand conveyors
- Simple hammer assembly
- Highly wear-resistant
- Installation dimension corresponding to approximate chain link dimension
- For medium to difficult operating conditions
- Run over sprocket wheels and pocket wheels, grooved wheels and flat wheels

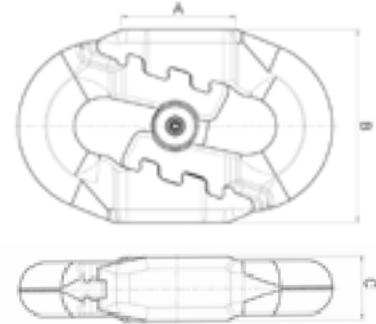

RUD Part no.	Chain d × t in mm	A	B	C	kg / Piece
55578	22 × 86	58	77	26	1.2
62113	26 × 100	62	89	29	1.8
53280	30 × 120	70	107	36	2.9
55357	34 × 136	82	117	40	4.3
7990647	38 × 144	95	113	45	5.8

Assembly of chain connector FL



CHAIN CONNECTOR VK

Properties

- For using in single and multi-strand conveyors, extremely robust and high wear volume
- Run only over sprocket wheels and flat wheels
- For difficult operating conditions

* Zinc-coated

** Fixing screw is overlapping on both sides

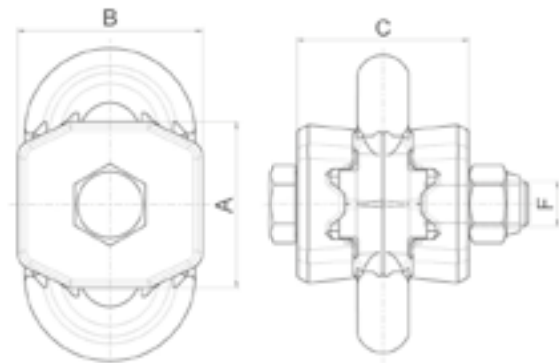

RUD Part no.	Chain d × t in mm	A	B	C	F	kg / Piece
54922*	8 × 31	27	29	31	M 8	0.1
54941*	10 × 38	32	36	36	M 10	0.3
54970	14 × 50	39	47	49	M 12	0.6
61326	16 × 64	51	57	57	M 16	1.1
55021	19 × 75	61	70	67	M 20	2
50039	19 × 120	61	70	67	M 20	2.3
55035**	22 × 86	70	79	77	M 20	2.8
51487**	26 × 100	80	90	88.5	M 24	4.6
60551**	30 × 120	100	105	105	M 30	8.1
7991616**	34 × 136	110	120	120	M 33	11.8



SPROCKET WHEELS

MULTI-PART // SINGLE-PART

SPROCKET WHEEL MULTI-PART*

Properties:

- With replaceable, highly wear-resistant tooth discs
- For difficult operating conditions

Ordering example for the complete wheel:

Sprocket wheel Multi-part
 For Chain 30 × 120
 Number of teeth 8
 Hole-Ø: ...mm
 Dimension C ...mm
 Dimension E ...mm
 Number in pieces 10

Ordering example for tooth discs:

Tooth disc Multi-part
 For Chain 19 × 75
 Number of teeth 8
 Number of pieces 10

For spare parts, refer to page 20.

Chain d × t in mm	No. of teeth	PCD Ø	A	B	Standard Dimension C	E _{max.}	F _{max.} = Hole-Ø in mm	Complete wheel approximately kg / piece
10 × 38	8	194	31	95	27.0	80	60	6.3
	12	291	31	140	27.0	80	80	15.5
	16	388	31	130	30.0	85	80	25.5
14 × 50	6	193	42	95	9.0	70	75	7.5
	8	256	42	120	25.0	75	85	11.6
	9	288	42	140	45.0	90	100	13.1
	10	319	42	160	45.0	90	100	20.6
	12	383	42	155	50.0	100	100	33.0
	13	415	42	155	50.0	100	100	38.0
14 × 64	7	287	42	140	45.0	90	100	16.0
	8	328	42	160	45.0	90	100	21.5
16 × 64	8	328	50	160	31.5	75	100	23.5
	9	368	50	185	30.5	125	125	41.5
	10	409	50	200	45.0	120	135	49.5
19 × 75	8	384	55	185	40.0	135	125	41.5
	10	479	55	220	45.0	120	140	71.5
22 × 86	8	440	55	185	40.0	120	120	76.5
	9	495	65	230	80.0	160	140	88.5
	10	549	65	270	80.0	160	170	95.5
26 × 100	8	512	78	270	100.0	200	180	110.0
	9	575	78	300	45.0	170	220	141.0
	10	639	78	340	80.0	160	210	155.0

* With tooth disc



Sprocket wheel multi-part*

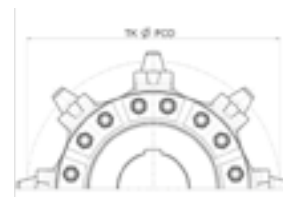
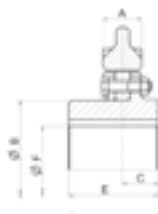

Sprocket wheel multi-part**

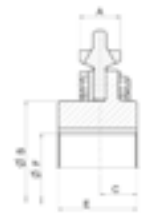

SPROCKET WHEEL MULTI-PART**

Chain d × t in mm	No. of teeth	PCD Ø	A	B	Standard Dimension C	E _{max.}	F _{max.} = Hole-Ø in mm	Complete wheel approximately kg / piece
30 × 120**	8	614	98	320	90.0	180	220	140.0
	9	690	98	320	90.0	180	230	170.0
	10	766	98	320	60.0	190	200	216.0
34 × 136**	8	697	107	320	110.0	220	220	195.0
	9	783	107	380	110.0	220	240	262.0
38 × 144**	8	738	108	365	110.0	220	220	270.0

** With replaceable, highly wear-resistant individual teeth

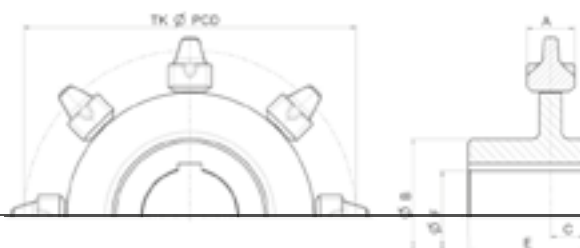

SPROCKET WHEEL SINGLE-PART

Properties:

- Highly wear-resistant for difficult operating conditions
- Unhardened for easy operating conditions

Ordering example:

Sprocket wheel Single part / Multi-part
 For chain 19 × 75
 Number of teeth 8
 Hole-Ø ...mm

Dimension C ...mm
 Dimension E ...mm
 Number of pieces 10
 Other dimensions on request.

Chain d × t in mm	No. of teeth	PCD Ø	A	B	Standard Dimension C	E _{max.}	F _{max.} = Hole-Ø in mm	Complete wheel approximately kg / piece
8 × 31	5	100	25	52	25.0	60	40	1.0
	7	139	25	92	27.5	55	65	2.6
	8	159	25	80	30.0	60	50	3.0
	10	198	25	95	17.0	47	65	3.6
	14	277	25	110	27.0	80	70	7.5
	16	316	25	120	27.0	80	80	9.2
10 × 38	22	434	25	120	45.0	90	80	16.1
	6	147	31	89	30.0	60	60	4.0
	7	170	31	114	25.0	75	85	3.3
	8	194	31	95	25.0	75	60	6.3
	10	243	31	90	20.0	60	50	6.5
	12	291	31	140	27.0	80	80	15.5
14 × 50	16	388	31	130	30.0	85	80	28.5
	6	193	42	92	40.0	80	75	7.5
	8	256	42	120	30.0	90	100	13.7
	10	319	42	160	45.0	90	110	20.0
16 × 64	16	510	42	160	60.0	120	120.0	31.5
	6	246	50	160	25.0	68	115	8.5
	8	327	50	145	45.0	90	100	18.0
18 × 64	9	368	50	160	30.0	125	115	26.5
	10	409	50	175	45.0	120	125	34.5
19 × 75	6	247	55	150	28.0	75	100	9.5
	8	384	55	180	40.0	135	110	40.5
22 × 86	9	575	78	220	45.0	120	120	85.0
	6	331	65	190	35.0	200	140.0	64.0



OUR TIP

TOOTHED SEGMENTS WITH INCREASED PITCH CIRCLE DIAMETER

Tooth discs and individual teeth, optimally adapted to the proportional chain extension given at the time of replacement. Available in dimensions 14x50 to 38x144 for all multi-part sprocket wheels. Prices on request!

Ordering example:

System _____	Part no. sprocket wheel _____
Chain _____	Drawing no. sprocket wheel _____
Teeth no. _____	Current chain length in % _____
Wheel no. _____	Planned installation date _____

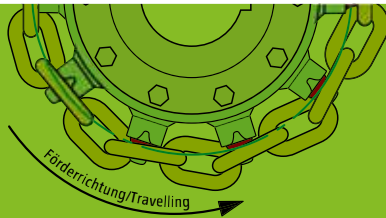
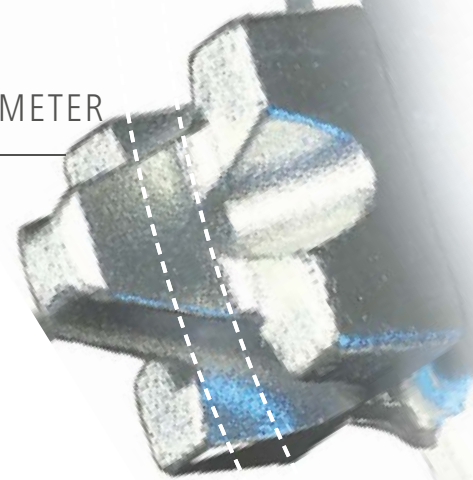

PREVIOUS – CHAIN RUNS AGROUND!

Indications of too heavily work chain:

- Uneven run,
- Hook formation at rear tooth flank,
- Flank clearance used up,
- Strong vibration at the drive,
- Chain falls only after several teeth on chain link support of the teeth

— · — · — · —
P.C.D. of standard sprocket wheel

— · — · — · —
The chain suited enlarged p.c.d. of the teeth

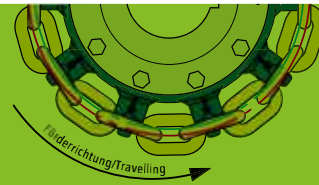

LATER – THE CHAIN WEAR IS COMPENSATED FOR BY USING A NEW TOOTH SEGMENT WITH LARGER TOOTH FLANK.

- The solution: sprocket wheels with increased pitch circle diameter.
- Replaceable tooth segments / individual teeth increase the life cycle of the complete sprocket wheel

Run-in behaviour of worn chain at the driving gear

- Distance of horizontal chain link – horizontal link support at the tooth (approx. 30 – 35 mm)
- Synchronisation of vertical link at the outermost tip of the tooth

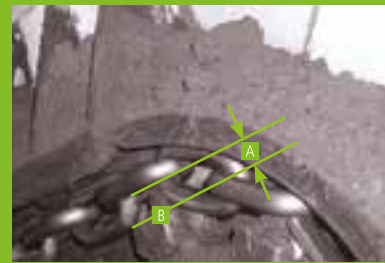

STRUCTURE OF SPROCKET WHEEL – MULTI-PART

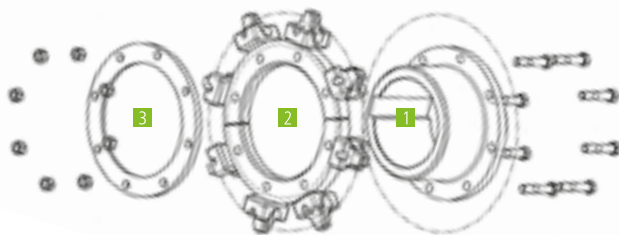

1. Hub disc
2. Tooth wheel segment
3. Counter disc

In case of new chain components, the horizontal link is on the horizontal link support of the tooth when running-in on the first tooth of the sprocket wheel. Chain elongation due to wear results in the chain mounting in the direction of the tooth tip. In this case, the vertical link is only taken from the tooth tip and there exists the danger of skipping the chain.

IN CASE OF NEW CHAINS, NEW TOOTH DISCS / INDIVIDUAL CHAINS SHOULD ALWAYS BE USED.

Tip: By inserting new single teeth with enlarged pitch circle diameter, the chain wear is compensated and the service life will be extended.

RUD REVERSION WHEELS

TYPE A // TYPE B // TYPE C



TYPE A



Properties:

- Grooved wheels with rim
- For using at tensioning stations

Chain d × t in mm	Corr. teeth number	PCD Ø	C*	E* (Type A or C)
10 × 38	8	194	15.5	45
	10	243	15.5	45
	12	291	15.5	45
14 × 50	8	256	21	60
	10	319	21	60
	12	383	21	60
16 × 64	8	327	25	70
	10	409	25	70
	12	490	25	70
18 × 64	8	323	27.5	80
	10	402	27.5	80
	12	482	27.5	80
19 × 75	8	384	27.5	80
	10	479	27.5	80
	12	574	27.5	80
22 × 86	8	440	32.5	90
	10	549	32.5	90
	12	658	32.5	90

Other sizes on request.



TYPE B



Properties:

- Grooved wheels without rim
- For using in loose side of the belt under the trough

Chain d × t in mm	Corr. teeth number	PCD Ø	C*	E=2C* (only Type B)
10 × 38	8	194	15.5	31
	10	243	15.5	31
	12	291	15.5	31
14 × 50	8	256	21	42
	10	319	21	42
	12	383	21	42
16 × 64	8	327	25	50
	10	409	25	50
	12	490	25	50
18 × 64	8	323	27.5	55
	10	402	27.5	55
	12	482	27.5	55
19 × 75	8	384	27.5	55
	10	479	27.5	55
	12	574	27.5	55
22 × 86	8	440	32.5	65
	10	549	32.5	65
	12	658	32.5	65

Other sizes on request.



TYPE C



Properties:

- Plain wheels with rim
- For both the use cases, however only possible when using flange attachments and very short scraper distances

Chain d × t in mm	Corr. teeth number	PCD Ø	C*	E* (Type A or C)
10 × 38	8	194	15.5	45
	10	243	15.5	45
	12	291	15.5	45
14 × 50	8	256	21	60
	10	319	21	60
	12	383	21	60
16 × 64	8	327	25	70
	10	409	25	70
	12	490	25	70
18 × 64	8	323	27.5	80
	10	402	27.5	80
	12	482	27.5	80
19 × 75	8	384	27.5	80
	10	479	27.5	80
	12	574	27.5	80
22 × 86	8	440	32.5	90
	10	549	32.5	90
	12	658	32.5	90

Other sizes on request.

* To order, please use the questionnaire on page 70 and / or pages 68/69.

RUD SUBMERGED OVERHUNG IDLER (SOI)

(SOI)

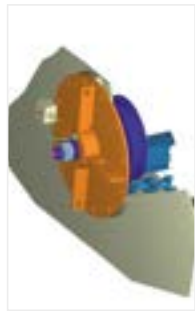

- Grooved wheels with rim for using in the hoistway
- Underwater sprockets vary from the normal reversion wheel only in the design of the "flying" shaft bearing, which are optimally designed by RUD for even these use cases. numerous use cases all over the world prove their high availability.

UNDERWATER SOI

- Ideal for wet de-ashing systems
- Electronic circulation control optionally possible
- Assembly of outer wall at the trough
- Suitable for modifying old systems
- High-quality, robust and easy-running bearing technology
- Optimised bearing seal
- Easily accessible for maintenance works
- Deliverable in all reversing wheel dimensions
- Two design versions: with or without bearing shield in fixed casing hub

1. SOI REVERSION WHEEL
2. TROUGH WALL
3. CHAIN
4. BEARING SIGN
5. TROUGH BOTTOM
6. SCRAPER

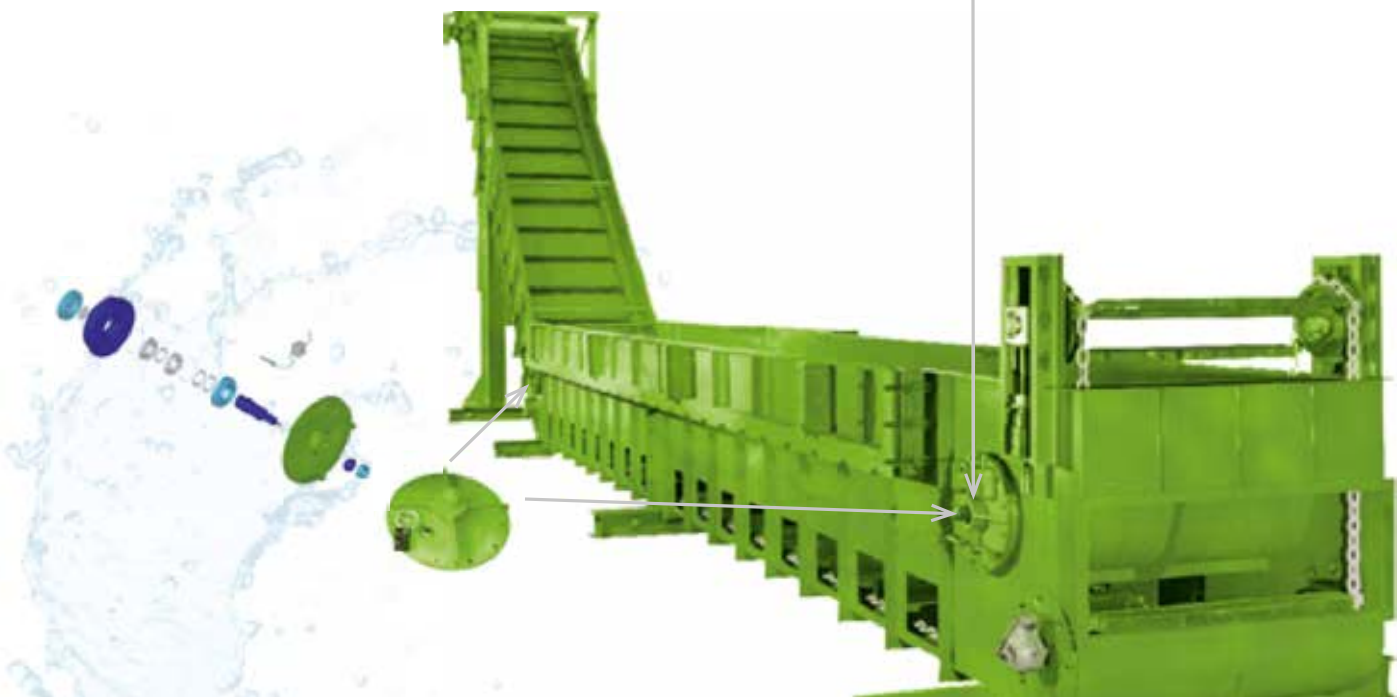
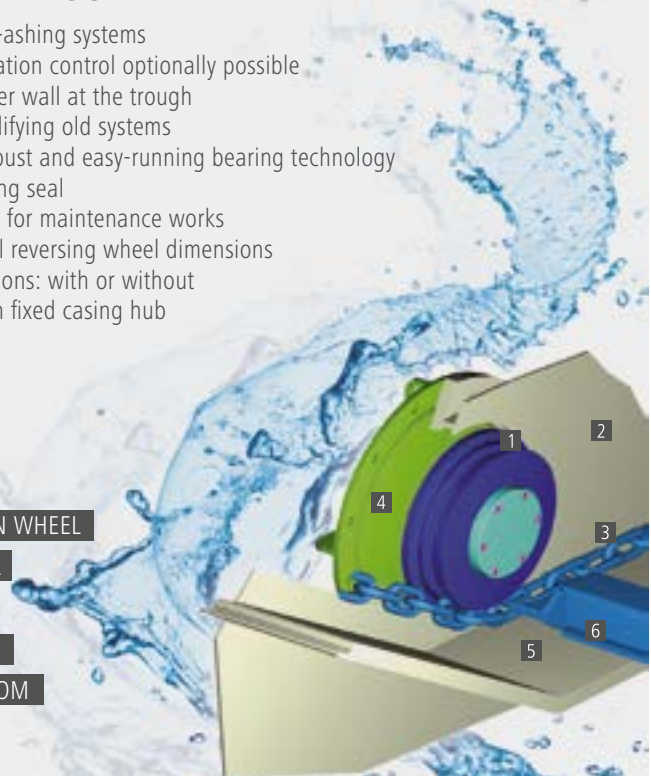

DESIGN SOI 1

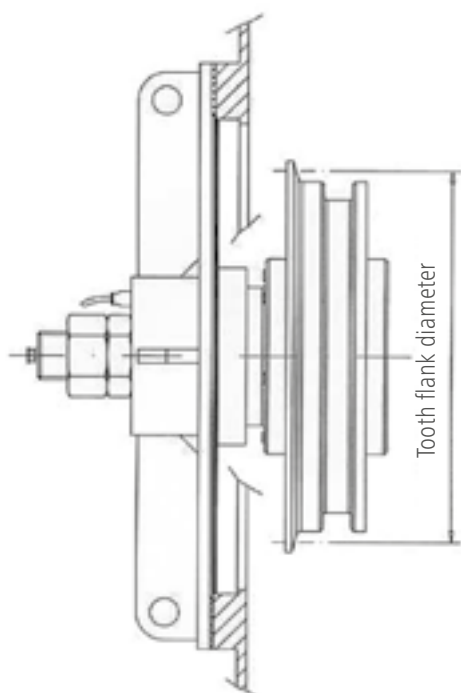

Chain $d \times t$ in mm	PCD \emptyset	Corresponding to the number of teeth
19 × 75	290	6
	384	8
22 × 86	331	6
	440	8
	549	10
26 × 100	386	6
	512	8
	639	10
30 × 120	426	6
	614	8
	766	10

Ordering example:

SOI 1 22 × 86-400/790-10

Reversion wheel with bearing shield for chain 22 × 86-R100 with 400 mm sprocket \emptyset and 790 mm Bearing shield \emptyset with electric circulation control (1), without automatic lubricator (0).
Surface condition: Primed

For connecting dimensions refer to dimension sheet on page 68.

DESIGN SOI 2

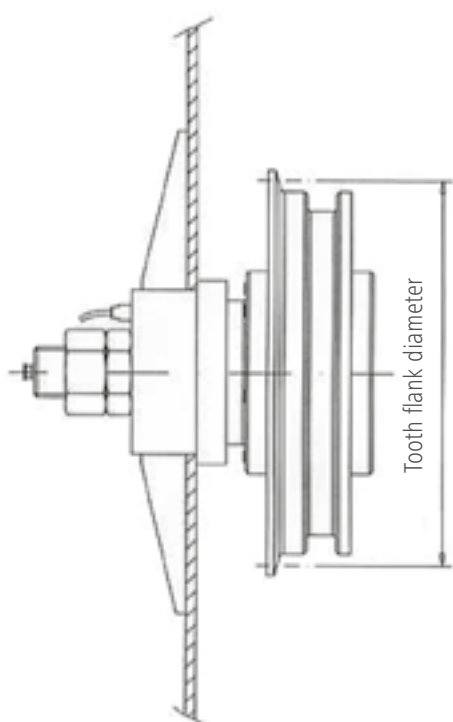

Chain $d \times t$ in mm	PCD \emptyset	Corresponding to the number of teeth
19 × 75	290	6
	384	8
	479	10
22 × 86	331	6
	440	8
	549	10

Ordering example:

SOI 2 22 × 86-400/790-10

Reversion wheel without bearing shield for chain 22 × 86-R100 with 400 mm sprocket \emptyset and 790 mm Bearing shield \emptyset with electric circulation control (1), without automatic lubricator (0). Surface condition: Primed

For connecting dimensions refer to dimension sheet on page 69.

For ordering, please use the questionnaire on page 68/69. Other designs and sizes available on request.

RUD ATTACHMENT SYSTEM SPROCKET WHEEL

ATTACHMENT FM



Properties:

- Screwed and can be clamped / screwed in the tensioned chain strand
- For scraper height up to 1.8 times the outer chain link width
- Variable scraper distance possible
- For rough operating conditions
- Run over sprocket wheels and plain wheels



RUD Part no.	Chain d × t in mm	A	B	C	E	F	G	H	I	kg / Piece
52738								40	5	0.1
52740	8 × 31*	27	29	15.5	2.5	10.5	M 8	45	10	0.1
52742								50	15	0.1
52743	10 × 38*	32	36	18	3	12.5	M 10	50	8	0.15
52744								65	10	0.4
52745	14 × 50	39	47	24.5	3	15.5	M 12	70	15	0.4
52746								75	20	0.4
52747								80	15	0.8
52748	16 × 64	51	57	28.5	4	20	M 16	90	25	0.8
52749								110	45	0.8
52751								110	30	1.4
52752	19 × 75	61	70	33.5	5	22.5	M 20	120	40	1.4
52755								130	50	1.4
52756								110	20	1.9
52757	22 × 86	70	79	38.5	5	26	M 20	120	30	1.9
52758								130	40	1.9
52759								130	30	3.0
7989190	26 × 100	80	93	43	6	30	M 24	160	60	3.0
52760	30 × 120	100	105	52.5	7	37	M 30	160	40	5.2

H = screw length
I = clamp length
* with head screw

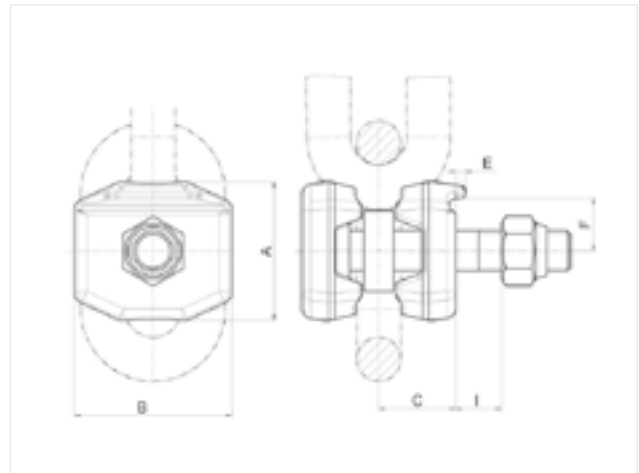

RUD ATTACHMENT SYSTEM SPROCKET WHEEL

MEZ-Z // F



ATTACHMENT MEZ-Z

Properties:

- For medium to difficult operating conditions
- For scraper height up to 1.5 times the outer chain link width
- Assembly and disassembly in case of tensioned chain possible
- Run across sprocket wheels and flat wheels

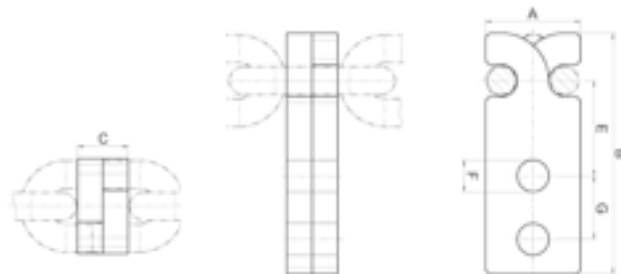

RUD Part no.	Chain d × t in mm	A	B	C	E	F	G	kg / Pair
61629	10 × 38	35	100	12	37	11	30	0.3
61630	14 × 50	50	130	30	52	13.5	36	1.25
61635	22 × 86	75	190	36	75	22	50	3.2

ATTACHMENT F

Properties:

- For medium and difficult operating conditions
- Directly welded
- For scraper height up to 1.5 times the outer chain link width
- Assembly and disassembly of scraper bars in case of tensioned chain loops
- Replacement for chain ends and chain brackets
- Run across sprocket wheels, pocket wheels and grooved wheels



RUD Part no.	Chain d × t in mm	A	B	C	E	F	G	K _{max}	kg / Pair
53215	18 × 64	126	35	30	65	17	40	45	0.64
55039	19 × 75	134	46	20	75	18	40	37	0.71
53065	22 × 86	139	46	20	80	18	40	51	0.71

Attachment F can also be used in pocket wheel system.

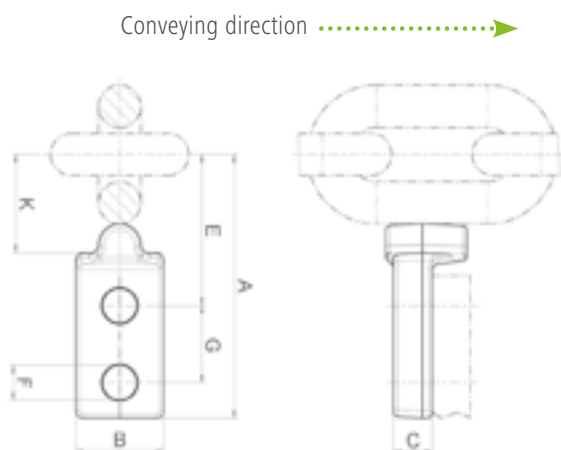

RUD ATTACHMENT SYSTEM SPROCKET WHEEL

DUOMOUNT // SSR

ATTACHMENT **DUOMOUNT**

Properties:

- For very high conveyance capacities up to 50 t/h
- Multiple link attachment
- For scraper height up to 2.5 times the outer chain link width
- Can be tensioned in the tensioned chain belt
- Scraper profiles of any shapes possible
- Variable scraper distance possible
- Highly wear-resistant
- Runs over sprocket wheels and grooved wheels

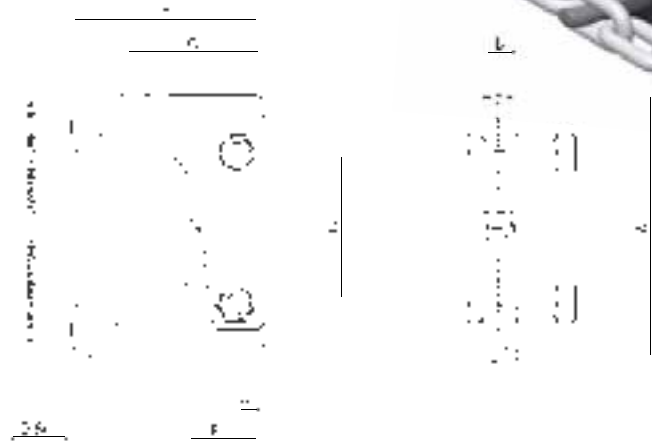

RUD Part no.	Chain d × t in mm	A	B	C	E	F	G	H	I	kg/ Piece
7995852*	26 × 100	214	30	112	155	65	120	25	20.5	5.2

* Distribution without screw!

ATTACHMENT SELF-LOCKING – REVERSIBLE SSR

Properties:

- For difficult operating conditions
- For double-strand conveyors
- Reverse operation possible
- Robust and easy
- Run across sprocket wheels and grooved wheels

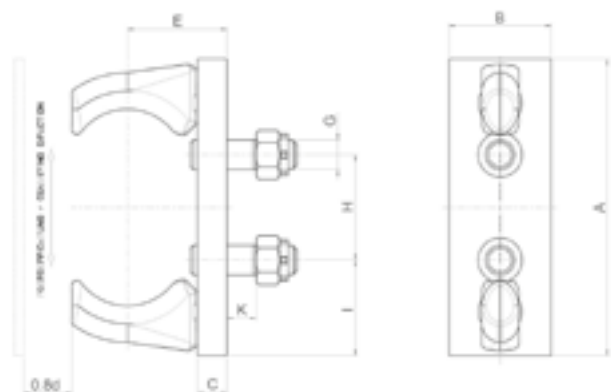

RUD Part no.	Chain d × t in mm	A	B	C	E	H	G	I	K	kg/ Piece
55333	10 × 38	82	24	10	30	58	M10	12	10	0.3
60812	19 × 75	175	60	20	58	65	M20	62.5	20	2.5
60343	22 × 86	200	70	20	68	71	M20	72.5	20	3.4
59991	26 × 100	235	80	20	72	85	M20	85	20	4.8
62331	30 × 120	280	90	25	85	98	M24	100	24	7.5

RUD ATTACHMENT SYSTEM SPROCKET WHEEL

SSRF

ATTACHMENT SELF-LOCKING – REVERSIBLE FLAT SSRF

Properties:

- For very high conveyance capacities
- Multiple link attachment
- For scraper height up to 2.5 times the outer chain link width
- Weldable at scraper profiles of any shapes
- Variable scraper distance possible
- Highly wear-resistant
- Run over sprocket wheels and grooved wheels

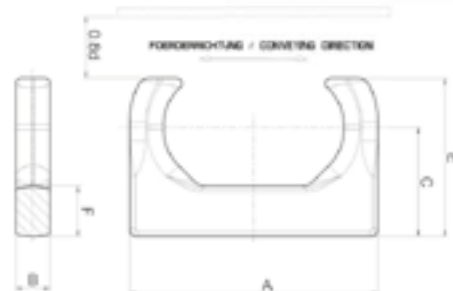

RUD Part no.	Chain d × t in mm	A	B	C	E	F	kg / Piece
7102723	14 × 50	110	16	50	73	25	0.5
7102724	16 × 64	135	19	59	83	30	0.8
63734	19 × 75	156	21	69	100	36	1.2
51297	22 × 86	182	25	80	116	37	2.0
63735	26 × 100	214	30	92	135	45	3.3
7102491	30 × 120	252	35	110	160	56	5.3
7102490	34 × 136	282	38	122	177	60	7.2
7989371	38 × 144	309	43	137	199	68	10.0



RUD SCRAPER BARS

SAFER SCRAPER OPERATION WITH MATCHED RUD STRANDS

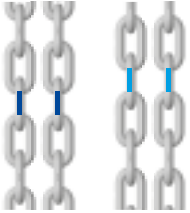

RUD PRODUCT ADVANTAGE:
LABELLING OF SUITABLE PAIR
USING COLOURS!

OUR SCRAPER BARS AND ATTACHMENTS FORM THE PERFECT SYSTEM
IN ASSOCIATION WITH OUR PAIRED CHAIN STRANDS:

- Simplest assembly and disassembly
- Optimal run across the pocket and sprocket wheels
- The suitable scraper design for every material to be transported
- Lower wear
- No scraper tilting
- Everything from a single source Chains, connectors, scraper bars and wheels

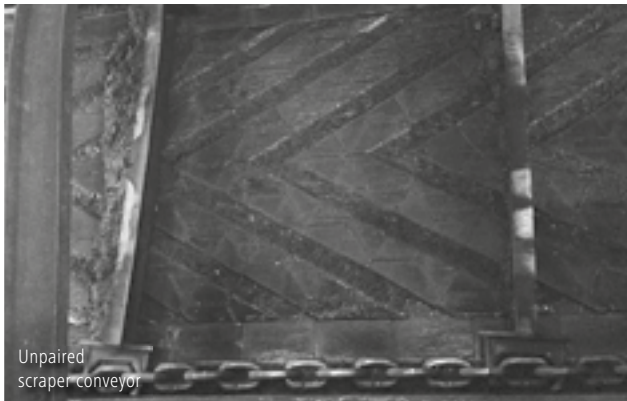

Strand lengths, production tolerance:

+ 0.4 % = 0.55 % max.
- 0.15 %
i.e. for 10 m length, max. difference 55 mm

length tolerance ΔL of matched chain left (Multiple-belt-conveyor)

ΔL = 0.05 % max., i.e. for e.g. 10 m long belts the max.
difference is. 5.0 mm. if the length of the belt is <8 m,
the largest pair tolerance = 4 mm.

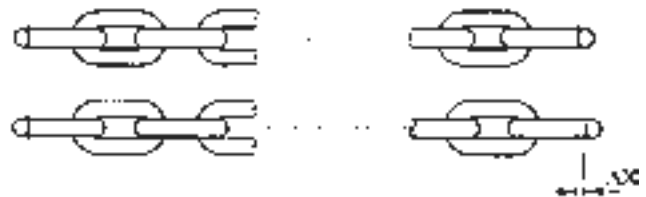

Strand series

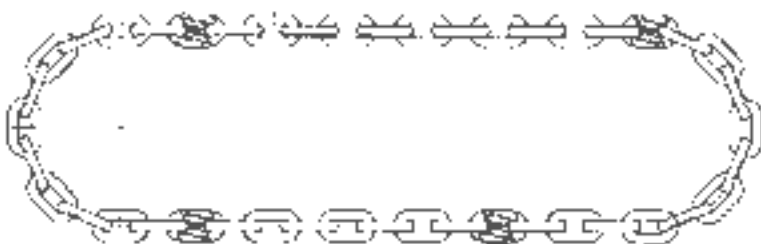

Pass strand

When ordering chain loops in millimetres,
we require the precise scraper distance
for distributing into individual chain strand
lengths.

RUD SCRAPER BARS

THE CORRECT SCRAPER BAR FOR YOUR REQUIREMENTS

RUD scraper bars are always optimally adapted to the requirements and operating conditions specified to us by the customer. We produce scraper bars as per the specifications of the customers, provided that no consultation or support is necessary. Alternatively, we suggest an optimal scraper version based on an intensive consultation, which is developed in the dialogue.

The following information is hence necessary and evaluated by us:

- Clear trough width of the conveyor as well as its exact line profile
- Trough bottom material and design
- Chain centre distance
- Maximum occurring / requested conveyance capacity
- Conveyance speed
- Properties of the material to be conveyed such as ??, bulk density, repose angle, particle size

USAGE EXAMPLES* – SCRAPER BARS AND ATTACHMENTS

Standard U profile with MEE-T attachment



Typical usage options:
Cleaning scraper conveyor

Standard scraper bar design for difficult conditions with SSRF or DUOMOUNT



Typical usage options:
Wet de-ashing systems

Standard angle profile with MEE-T attachment

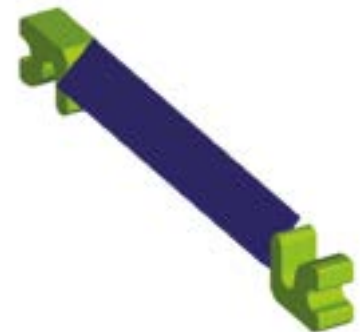

Typical usage options:
Coaling systems / coal feeders
Bunker discharge conveyor

* Other scraper designs on request; if necessary, use the sketch on page 67



RUD SCRAPER BARS

AREAS OF APPLICATIONS



DE-ASHER WITH SSRF ATTACHMENT

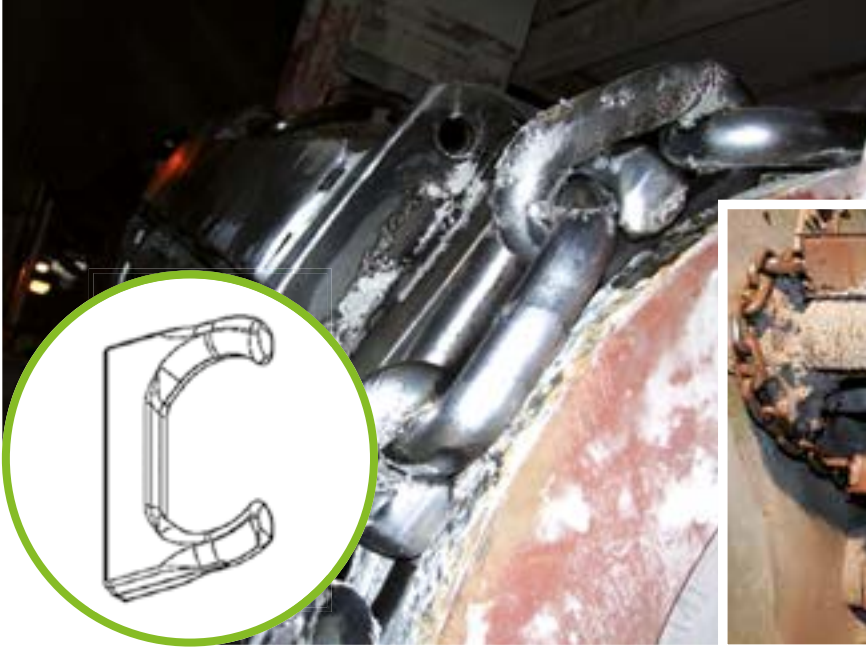

LANDFILL WASTE BUNKER DISCHARGE WITH MEE-T ATTACHMENT

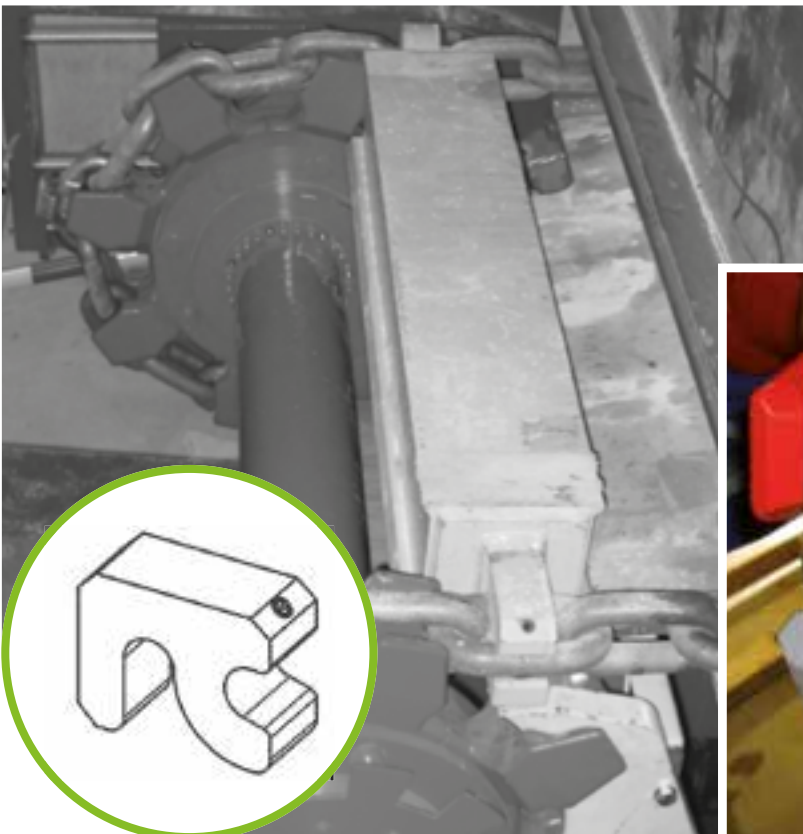

DE-ASHER WITH F ATTACHMENT

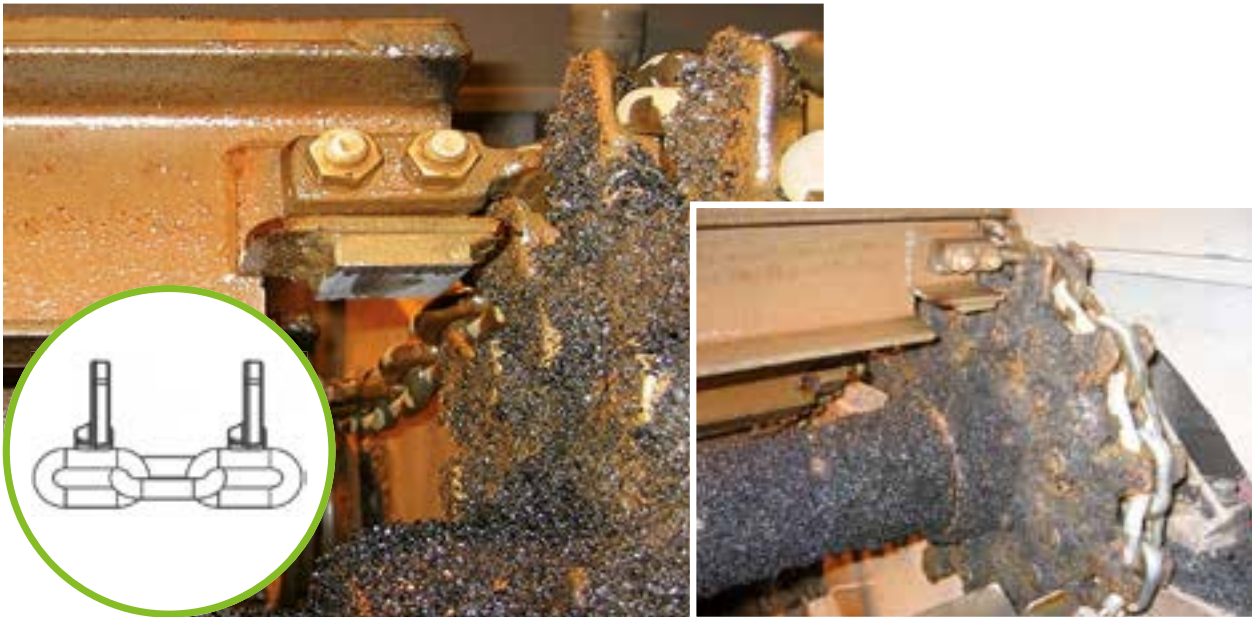

DE-ASHER WITH FM ATTACHMENT



RECLAIMER SCRAPER BARS WITH SYSTEM 65



RUD SYSTEM POCKET WHEELS

MULTI-PART POCKET WHEEL SYSTEM

Properties:

- With replaceable, highly wear-resistant pocket wheel discs
- For difficult operating conditions
- Preferably used as driving gear

Ordering example

for the complete wheel:

Multi-part pocket wheel
 For chain 19 × 75
 Pocket number 8
 Hole-Ø ... mm
 Dimension C ... mm
 Dimension E ... mm
 Number in piece 10

Ordering example for pocket wheel disc:

Multi-part pocket wheel
 For chain 19 × 75
 Pocket number 8
 Number in piece 10

Chain d × t in mm	Z	PCD Ø	A	B	C	E _{max.}	F _{max.} = Hole-Ø in mm	Complete sprocket wheel approx. kg/piece
10 × 38	8	195	35.0	80	30	80	45.0	6.5
14 × 50	8	256	49	120	35	100	80.0	13.1
	9	288	49	140	45	90	100.0	15.2
	10	320	49	155	40	105	100.0	23.8
	12	384	49	155	40	105	100.0	37.4
16 × 64	8	327	56	160	45	125	110	27.2
	10	409	56	195	45	125	140	45.4
18 × 64	8	328	64	150	45	125	90	30.5
	10	409	64	150	45	125	140	45.4
19 × 75	8	384	66	185	45	145	130	40.5
	10	479	66	225	45	145	150	68.0
22 × 86	7	387	77	155	65	165	90	45.0
	8	440	77	200	65	165	120	59.5
	10	549	77	225	65	165	140	106.0
26 × 100	8	512	91	235	75	175	150	89.0
	10	639	91	335	75	175	230	215.0
30 × 120	9	690	108	320	80	170	180	189.0
	10	766	108	360	90	180	240	243.0
34 × 136	9	783.0	122.0	380	90.0	240	260.0	335.0
38 × 144	8	738.0	130.0	355	125.0	250	240.0	316.0

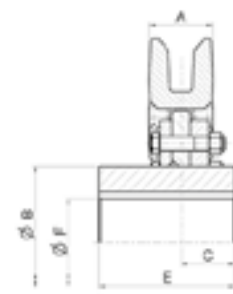

RUD SYSTEM POCKET WHEELS

SINGLE-PART POCKET WHEEL SYSTEM

Properties:

- Highly wear-resistant
- For medium and difficult operating conditions
- Especially suitable as guide wheel

Ordering example:

Single-part pocket wheel
 For Chain 19 × 75
 Pocket Number 8
 Hole-Ø ... mm
 Dimension C ... mm
 Dimension E ... mm
 Number in piece 10
 Other sizes on request.

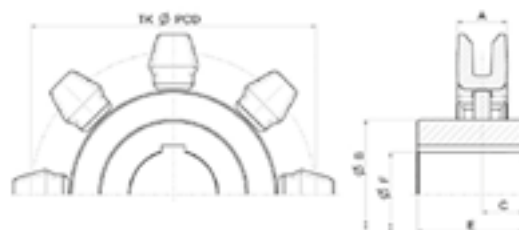

Chain d × t in mm	Z	PCD Ø	A	B	C	E _{max.}	Chain wheel compl. ca. kg / Pcs.	F _{max.} = Hole-Ø in mm
8 × 31	5*	100.3	40	62	25.0	68	4.5	45.0
	6	119.7	45	—	22.5	45	2.9	40.0
	7	139.3	40	70	27.5	55	4.5	40.0
	10*	198.1	43	80	25.0	50	6.5	48.0
10 × 38	5*	123.0	55.0	75	32.0	80	3.5	45.0
	6	147.0	35.0	85	30.0	80	3.5	55.0
	8	194.7	35.0	100	25.0	80	11.5	65.0
	10*	243.0	35.0	100	30.0	80	21.0	65.0
	12	291.0	35.0	100	30.0	80	22.0	65.0
14 × 50	6	193.0	49	105	30	75	7.5	70.0
	7	225.0	49	135	30	65	12.0	85.0
	8	256.0	49	120	30	100	13.5	80.0
	10	319.0	49	—	30	70	29.0	120.0
	12	383.0	49	160	30	100	23.5	120.0
16 × 64	6	247.0	56	140	45	120	15.1	85.0
	8	328.0	56	160	45	125	21.5	120.0
	10	409.0	56	195	45	125	35.4	140.0
18 × 64	6	247	63.5	140	45	120	20.1	95.0
	8	328	63.5	150	45	125	25.5	110.0
19 × 75	8	385	66.0	185	45	130	40.0	125.0
	10	479	66.0	225	45	145	50.0	150.0
22 × 86	6	332.0	77.0	—	50.0	100	27.0	140.0
	7	386.0	77.0	265	65.0	165	50.0	150.0
	8	440.0	77.0	185	65.0	165	50.5	135.0
	10	549.0	77.0	300	65.0	165	100.0	180.0
26 × 100	8	512.0	91.0	235	75.0	175	90.0	150.0
	10	639.0	91.0	335	75.0	175	110.0	250.0
30 × 120	8	614.0	108.0	320	55.0	210	180.0	220.0

* without heat treatment



RUD SYSTEM POCKET WHEEL



ATTACHMENT MEE-T

MEE-T IN ONE PART FOR SYSTEM POCKET WHEEL

F

Properties:

- For difficult operating conditions
- Scraper height up to 1.5 times the chain link width
- Double-strand conveyor and multiple- strand conveyor systems
- Can be welded to anything
- Securing with locking pin if necessary
- Run over pocket wheels and plain wheels
- Deliverable with and without pin locking

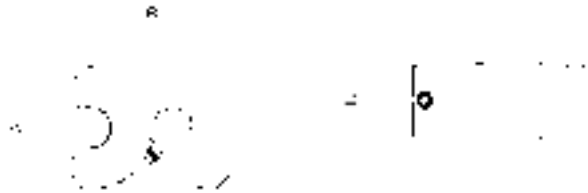

RUD Part no. with pin locking	RUD Part no. without pin locking	Chain d × t in mm	A	B	C	E	kg / Piece
62930	62929	10 × 38	35	43	16	27	0.2
55158	50380	14 × 50	50	60	20	38	0.4
62676	50383	16 × 64	56	70	28	44	0.6
62677	50417	18 × 64	62	78	25	49	0.6
62678	50418	19 × 75	65	80	35	50	1.0
62680	50419	22 × 86	75	95	40	60	1.6
62681	50423	26 × 100	90	111	45	70	2.5
62683	50424	30 × 120	105	128	55	81	4.6
62685	50425	34 × 136	115	144	65	91	6.0
7992593	–	38 × 144	128	160	65	101	7.3

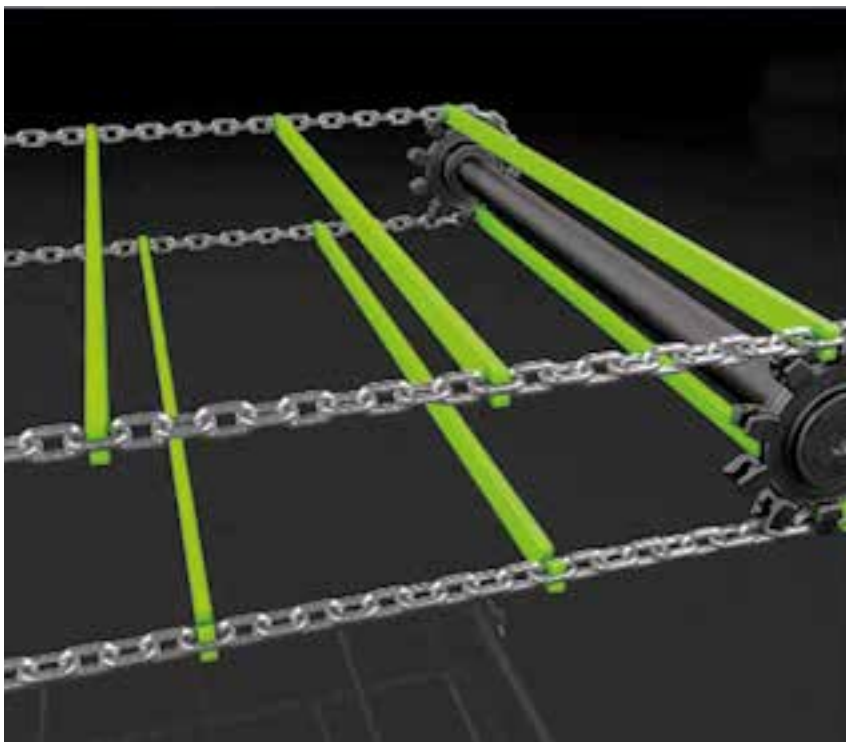

RUD SYSTEM POCKET WHEEL

ATTACHMENT MEZ-T



PIVOT FITTING ATTACHMENT MEZ-T IN TWO PARTS-POCKET WHEEL

Properties:

- For medium to difficult operating conditions
- For scraper height up to 1.5 times the outer chain link width
- Assembly and disassembly in case of tensioned chain possible
- Double-strand conveyor and multiple-strand conveyor systems
- Run over pocket wheels and plain wheels

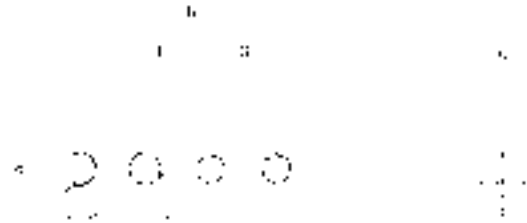

RUD Part no.	Chain d × t in mm	A	B	C	E	F	G	kg/Pair
7102680	10 × 38	35	100	12	37	11.0	30	0.3
62686	14 × 50	50	130	16	52	13.5	36	0.7
62687	16 × 64	56	150	24	58	17.5	40	1.3
63039	18 × 64	62	155	24	63	17.5	40	1.5
63040	19 × 75	65	165	30	65	17.5	46	2.0
62688	22 × 86	75	190	36	75	22.0	50	3.2
62689	26 × 100	90	220	44	86	22	60	5.5
62690	30 × 120	105	250	56	96	26	70	9.3



RUD BUCKET ATTACHMENT SYSTEMS

AT A GLANCE

	Bucket width [mm]	Max. conveyance capacity [m ³ /h]	Max. dimension between axels [m]	
RUD Central chain				Recommended traction mechanism:
	250–1100 simple 2 × 250– 2 × 1000 tandem	600 1200	70	
RUD System 65⁺				Recommended traction mechanism:
	250–1600	1100	65	
RUD System 2win⁺				Recommended traction mechanism:
	250–1250	700	60	
RUD System RUca				Recommended traction mechanism:
	250–630	20–210	35	
RUD System SWA				Recommended traction mechanism:
	400–1250	30...275	40	
RUD fabric belt				Recommended traction mechanism:
	160–1250	700	45	
RUD steel cord belt				Recommended traction mechanism:
	315–1600	1200	120	



Problems of the DIN-Systems

- Chain bracket has a double function
- Transmission of tension of the chain loop
- Fixing the bucket to the chain loop and absorbing bucket strain
- Weak point double-function may lead to fatigue fractures
- Additional consequences may be loose screw fittings
- Even over-dimensioning in heavy conveyor operations does not solve these problems

Solution RUD multi-link-fastenings 2win and System 65 (see page 42; 45 – 47)

- Assembly over several chain links
- No transmission of tension from the chain to the attachment
- Gentle introduction of the scooping force into the chain strand
- Minimizing wear in the chain joints

	Max. conveyance speed [m/s]	Recommended granulation [mm]	Max. temperature of material to be conveyed [°C]	Recommended material to be conveyed
RU50, RU80, RU150, RU200; Breaking Force 570–2000 kN				
	1,7	120	250	Cement, limestone, gravel, coke, slag, clinker
RU50, RU80, RU150, RU200; Breaking Force 570–2000 kN				
	1,5	120	200	Cement, limestone, gravel, coal, sugar beets, clinker, potassium, rock, salt, fertiliser, Soda
Round link steel chain 14 × 50–34 × 136; Breaking Force 140–720 kN				
	1,5	100	200	Cement, limestone, lump lime, Soda, gypsum, fertiliser, filter dust
Round link steel chain 16 × 64 – 26 × 100; Breaking Force 100 – 265 kN				
	0,9...1,4	Chain Ø x 0,5 bis Chain Ø x 1,2 depending on application	200	Building materials, potash and salt, sugar, lime, gypsum, REA gypsum, filter dust, cement
Round link steel chain 16 × 64 – 30 × 120; Breaking Force 180 – 640 kN				
	0,6...0,8	100	200	Fertilizer, difficult to unload conveyed goods, for gentle transport of conveyed material
Fabric belts are available with 4–6 EP 630–EP 1600 inserts				
	1,7	40	120	Cement, limestone, gypsum, sugar, coal, aluminium oxide, sand, potassium, rock salt, slag, filter dust
Steel cord belts are available with a breaking force of 800...3150 N/mm belt width				
	1,7	80	120	Cement, limestone, coal, potassium, rock salt, slag

RUD CHAIN ELEVATORS

AT A GLANCE



These are specially designed for the dust-free, vertical conveyance of powdery, granular, lumpy and high temperature bulk materials.

Highly wear-resistant chains, traction wheels or sprockets ensure that even abrasive materials are transported reliably. Specially designed chaintype

bucket elevators are available in either centrifugal/gravity, positive or central discharge designs dependent on the application.

CONVEYING CAPACITIES, REFERENCE VALUES FOR APPROX. 75 % FILLING

Bucket DIN 15233												
	Width [mm]	160	200	250	315	400	500	630	800	1000	1250	1600
	Conveyance speed [m/s]	1.05	1.05	1.15	1.15	1.20	1.20	1.34	1.34	1.48	1.48	1.48
	Conveyance capacity [m³/h]	9	11	20	25	44	61	94	129	196	305	391
Bucket DIN 15234												
	Width [mm]	160	200	250	315	400	500	630	800	1000	1250	1600
	Conveyance speed [m/s]	1.05	1.05	1.15	1.15	1.20	1.20	1.34	1.34	1.48	1.48	1.48
	Conveyance capacity [m³/h]	14	17	31	39	70	98	151	207	304	473	605
Special bucket												
	Width [mm]	160	200	250	315	400	500	630	800	1000	1250	1600
	Conveyance speed [m/s]	1.15	1.15	1.25	1.25	1.28	1.33	1.49	1.49	1.48	1.48	1.48
	Conveyance capacity [m³/h]	18	23	41	52	91	133	209	287	353	558	715
High-capacity bucket conveyor												
	Width [mm]	160	200	250	315	400	500	630	800	1000	1250	1600
	Conveyance speed [m/s]	1.15	1.15	1.25	1.25	1.28	1.33	1.49	1.49	1.48	1.48	1.48
	Conveyance capacity [m³/h]	27	34	59	75	129	185	288	397	499	789	1010

DIMENSIONS*

Bucket width	b	160	200	250	315	400	500	630	800	1000	1250	1600
Head	a	724	724	904	904	1004	1160	1264	1460	1673	1747	1747
	c	560	560	695	695	785	885	955	1160	1320	1340	1340
	h	850	850	1050	1050	1250	1450	1600	1800	2100	2300	2300
Funnel	e	1000	1000	1250	1250	1400	1650	1800	2100	2450	2550	2550
	f	280	355	450	545	660	770	900	1110	1300	1600	2000
Foot	a	724	724	904	904	1004	1160	1264	1460	1673	1747	1747
	g	1220	1220	1350	1350	1500	1700	1900	2100	2450	2500	2500
	t	670	670	800	800	880	970	1080	1300	1550	1550	1550
	s	1320	1320	1450	1450	1600	1800	2000	2200	2750	2750	2750
Expansion Distance	E	900	1000	1200	1300	1500	1600	1800	2100	2500	2900	3500

Not permitted for snub roller & mid-discharge bucket elevators.

RUD CHAIN ELEVATORS

DESCRIPTION

The bucket elevator casings are selfsupporting, but they require horizontal guides at least every 15 meters and below the elevator head. The bucket elevator head comprises a lower section with doors to access the adjustable discharge plate, and braced bearing mountings, for the pedestal bearings which support the drive shaft, the shaft exit points use grease filled radial shaft seals. The upper sections comprise a multipart removable hood with an inspection door. A drive platform is mounted on the side of the lower part of the head for supporting a wide variety of commercially available drives. If required a maintenance platform and or an overhead support/ service beam can be fitted if required. An elevator drive normally consists of a geared motor unit, which is normally connected to a frequency controller for maintenance purposes. For higher power requirements, we recommend a drive unit with a bevel spur gearbox, and standard motor optionally with ancillary drive. Starting characteristics can be optimized by a hydraulic clutch or an electric soft start.

The double or single leg casing is torsionally rigid sheet metal housing, constructed of standard section lengths with flange connectors. The maintenance and assembly door position should preferably be located in the elevators raising casing leg, approximately 0.8 m above a platform.

The elevator boot is optionally designed with either internal, oil-filled bearings or external pedestal bearings. With external bearings, the shaft exit points are sealed by gray cast-iron stuffing boxes. There are large assembly doors and cleaning doors on both sides. The chain takeup tension is generated by a weight or spring-loaded spindle take-up device.

Depending on the type of chain used, RUD driving wheels are either non-toothed chain pulleys with replaceable, highly wear-resistant segments, or toothed sprocket wheels with replaceable, highly wear-resistant teeth. The RUD return wheels have replaceable, highly wear-resistant segments which in certain designs incorporate guide discs.

Buckets are manufactured according to DIN or our works standard. The materials used are steel, stainless steel, or rubber.

Buckets are attached by chain shackles, bolted clamping clips, plug-in attachments or angle brackets.

The chains are either hardened, round link chains to DIN Standard or works standard chain designs made of special, highly wear-resistant alloy steel. Engineering style chains are also used, as either double or single central chains.

Standard safety devices such as speed governors and level indicators, to monitor the operating status of the bucket elevator are incorporated.

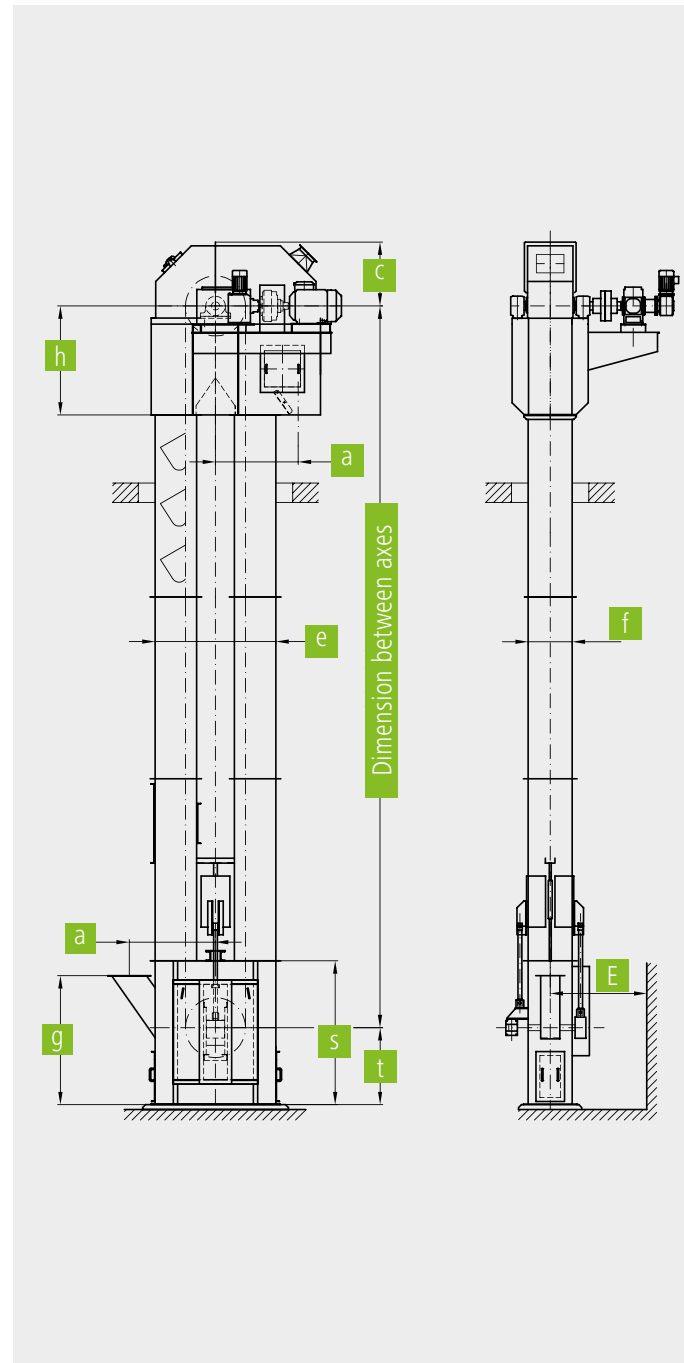

Additional accessories are available.

NEW

RUD RUCA BACKWALL BUCKET ATTACHMENT



NEW

THE RUD ALTERNATIVE TO DIN SYSTEM

SYSTEM COMPARISON		DIN	RUca	
		Single-link attachment	Single-link attachment	Multiple-link attachment
	Brace support in the chain strand	+	+	+++
	Suitability for coarse-grained materials	+	+	+++
	Suitability for high-capacity buckets			+++
	Wear and tear on attachments	++	+	+
	Wear and tear on chain	+	++	++
	Component break resistance	+	++	+++
	Soggy / viscous materials	+	+	++
	System reliability / availability	+	++	+++
	System / Chain, Safety	-	+	+

RUca – The RUD alternative to DIN system

RUca only available as a system in conjunction with RUD chains and RUD chain connectors.



MOUNTING SEQUENCE

1	2	3	4	5
Insert the bolts.	Pivoting the upper RUca half into the chain.	Pivoting the lower RUca half into the chain.	Insert the safety spring.	Fix the bucket.



Scan the QR code and find out more about RUca!

RUD RUCA BACKWALL BUCKET ATTACHMENT

BUCKET REAR MOUNTING RUca

Properties:

- RUD endless chain strands must be used
- Short assembly and disassembly Butimes, without special tools
- Travel over plain wheels
- Higher component break resistance
- Suitable for replacing all the DIN bucket attachments in round steel link chain bucket elevators except side-wall attachments
- Less wear and tear on chain
- No oversized components

Ordering example:

For the order or quotation the following information is required:

- Number of buckets for the whole bucket elevator
- Chain size acc. to DIN 764/766 resp. DIN 5696/5698 (number of chain links)
- Chain shackle size acc. to DIN 745/5699 or if number of buckets are unknown
- Real axle distance of the bucket elevator
- Chain roller diameter of the drive wheels and

reversing wheels

- Chain size acc. to DIN 764/766 resp. DIN 5696/5698 (number of chain links)
- Chain shackle size acc. to DIN 745/5699

Request for every single bucket elevator please.

RUD part-no. RUca	RUD partno. Test set ^{*)}	Ruca size	Chain d x t	min. breaking load	RUca dimensions								Usual DIN bucket DIN 15 233 DIN 15 234	
					A	B	G	H	I	J	K ^{*)}	Mass		
[--]	[--]	[--]	[mm]	[kN]	[mm]	[mm]	[mm]	[mm]	[mm]	[mm]	[mm]	[mm]	[kg]	[mm]
7909112	7909613	16	16 x 64	100	123	38	M16	37	63	75	45 (63 / 37 / 30)	0.79	250 / 315 x 200	
7909113	7909614	18	18 x 64	127	130	45	M20	45	70	79	47 (70 / 42 / 34)	1.12	315 x 200 or 400 x 228	
7909114	7909616	19	19 x 75	142	144	45	M20	45	80	83	49 (80 / 47 / 37)	1.26	400x228	
7909115	7909617	22	22 x 86	190	165	53	M24	52	91	101	60 (91 / 52 / 43)	1.95	500 x 250	
7908918	7908536	26	26 x 100	365	190	53	M24	52	105	113	65 (105 / 60 / 50)	2.35	630 x 280	

*1) in brackets: usual shackle acc. to DIN 5699 / DIN 745 and their dimension „a“ (shackle pitch / „a“_{DIN 5699} / „a“_{DIN 745})

*2) includes 2 chain strands and RUca attachments for minimum 3 buckets

BACKWALL BUCKET ATTACHEMENT RUca

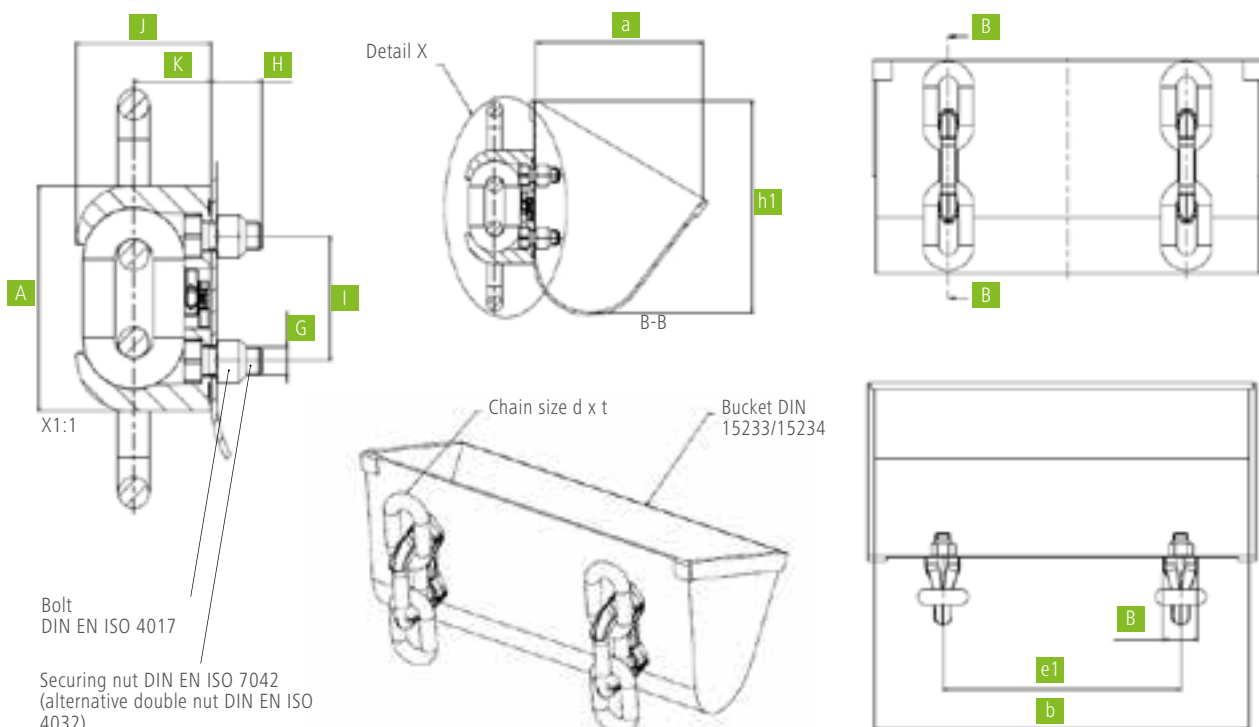

RUD 2WIN BACK-WALL BUCKET ATTACHMENT



BACK-WALL ATTACHMENTS 2WIN

Properties:

- For using bucket conveyors with up to 60 m height
- Endless chain strands can be used
- Short assembly and disassembly times, without special tools
- Bucket attachments runs over sprocket wheels and plain wheels
- Suitable for replacing all the DIN bucket attachments in round steel link chain bucket elevators except side-wall attachments

RUD Part no.	Chain d × t in mm	A	B	G	H	I	K ^(*)	Weight [kg]
7998699	14 × 50	124	40	M14	30	56	39	0.85
7998700	16 × 64	156	43	M16	35	63	45	1.15
8503775	19 × 75	180	50	M20	40	80	53	1.7
8503776	22 × 86	207	58	M24	50	91	62	2.7
8503777	26 × 100	240	60	M24	50	105	71	3.4
7996145	30 × 120	288	75	M30	60	126	84	6.5
7993608	34 × 136	327	92	M36	70	147	96	10.2

*1) in brackets: usual shackle acc. to DIN 5699 / DIN 745 and their dimension „a“ (shackle pitch / „a“_{DIN 5699} / „a“_{DIN 745})

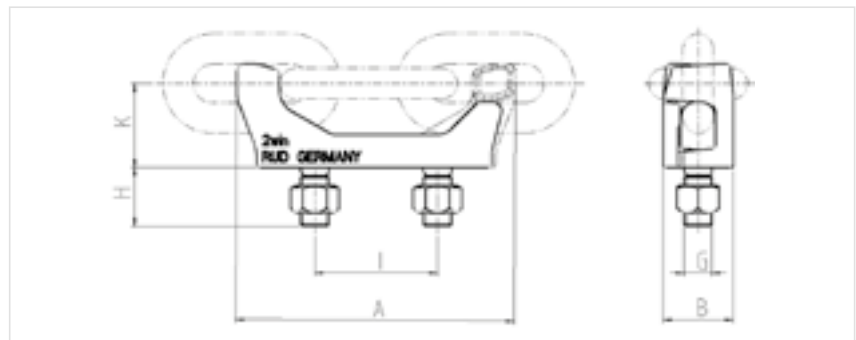

ASSEMBLY SEQUENCE

1	2	3	4	5
Rotate the brackets against each other	Thread 2win in the chain	Close 2win	Mount the brackets	Mount the buckets



RUD SWA SIDE-WALL ATTACHMENT

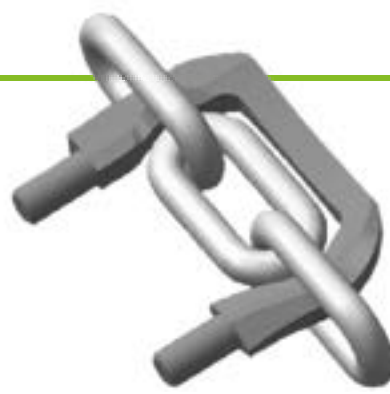

SIDE-WALL ATTACHMENTS SWA

Properties:

- For using in slow-running bucket elevators with gravity drain, central discharge bucket conveyors and return-feed bucket conveyors
- Endless chain strands can be used
- Easy assembly in case of variable bucket distance
- Two-link bucket attachment for a smooth run across the sprocket wheels

RUD Part no.	Chain d × t in mm	A	B	G	H	I	K	Weight [kg]
7992042	16 × 64	140	81	M16	35	105	37	0.6
7982949	19 × 75	164.4	98.5	M20	40	124	47	1.3
7992040	22 × 86	190	112	M20	40	145	51	1.4
7987910	26 × 100	224	130.5	M24	45	170	60	2.8
7990871	30 × 120	258.5	153.5	M30	55	198.5	71	3.5

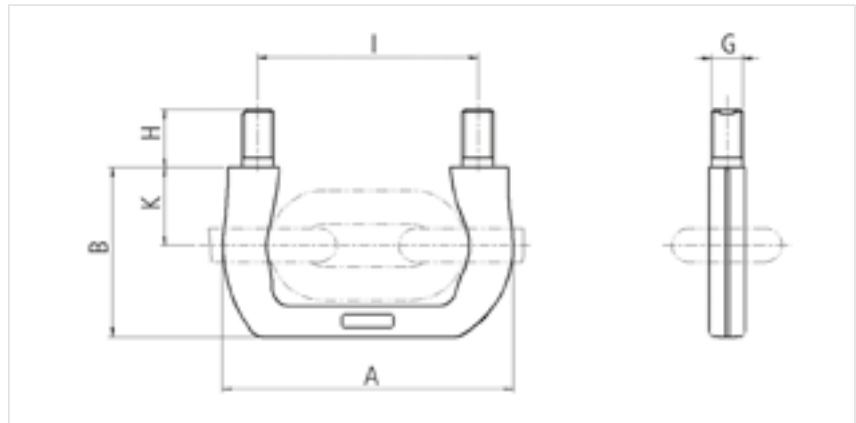

ASSEMBLY SEQUENCE



For central discharge bucket conveyors

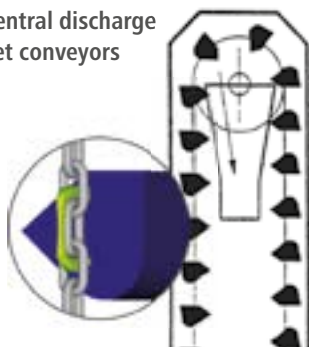

Centre discharge bucket elevators

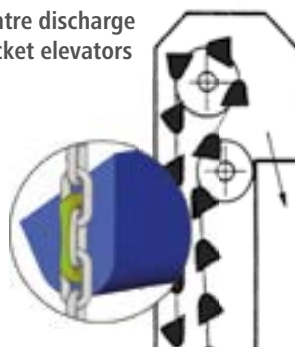

RUD CHAIN WHEEL

FOR BUCKET ELEVATORS 2WIN, RUCA, SWA



CHAIN WHEEL FOR BUCKET ELEVATOR

Properties:

- Especially suitable for RUD systems 2win and sWa
- Finish-drilled and grooved as per customer requirement
- Robust welded construction with replaceable bearing ring segments
- Hardened bearing ring segments for the drive
- Unhardened bearing ring segments for deflection

Ordering example:

Chain sprockets for system 2win
 Design Complete
 PCD Ø in mm 710
 For Chain 19 × 75
 Number in pieces 4
 Hub bore hole 120^{H7}
 Segments Hardened

Special grooved wheels and guide wheels on request.

Spare parts:
 Per chain roller a set of segments

Chain d × t in mm	PCD Ø	B	C	D	Weight of the complete sprocket approx. kg/piece
14 × 50	500	19	55	120	70
16 × 64	630	22	62	140	135
19 × 75	710	27	71	160	170
22 × 86	800	29	79	170	250
26 × 100	900	33	93	200	350
30 × 120	1000	40	110	200	450
34 × 136	1250	44	114	220	500

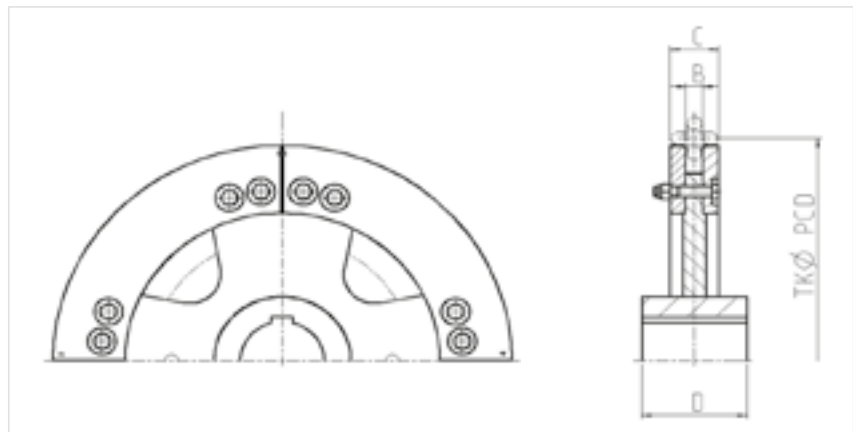

ASSEMBLY OF CHAINS ACROSS THE SMOOTH DRIVE CHAIN WHEELS IN THE BUCKET ELEVATOR



RUD BUCKET ATTACHMENT

SYSTEM 65



System 65 – RUD bucket attachment: **NEW** with integrated wear mark

BUCKET ATTACHMENT SYSTEM 65

Chain d × t in mm	Flat steel single part	Plug in attachment flat	Plug in attachment round	A	B	C	D	E	F	G	H	Complete weight [kg]
14 × 50	7908368	61160	61162	150	55	8	33	25	100	49	93	1.0
16 × 64	7908380	61163	61165	190	65	10	40	31	128	58	110	1.9
19 × 75	7908381	61166	61168	230	75	12	45	40	150	68	130	3.0
22 × 86	7908382	61169	61171	260	85	12	50	44	172	80	158	4.6
26 × 100	7908383	61172	61173	290	100	12	61	45	200	94	172	6.4
30 × 120	7908384	61174	61175	340	125	12	75	50	240	109	190	9.7
34 × 136	7908386	54713	54714	380	130	15	80	54	272	122	210	12.8

Properties:

- For heavy operating conditions in the bucket elevator area
- Robust and highly wear-resistant
- Easy assembly and disassembly of buckets on the chain

The complete version includes the following components:

- 4 × flat steel part with wear mark and wear-resistant steel
- 1 × plug-in attachment round,
- 1 × plug-in attachment flat

A repeat order for individual parts such as flat steels and plug-in attachments can also be placed separately.

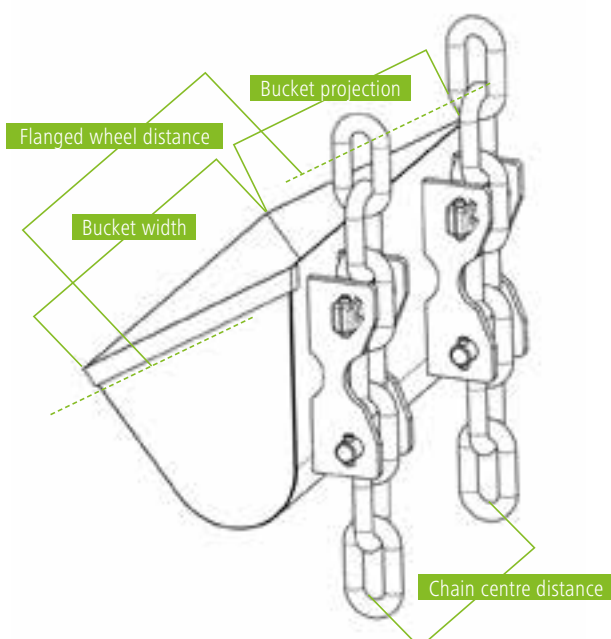
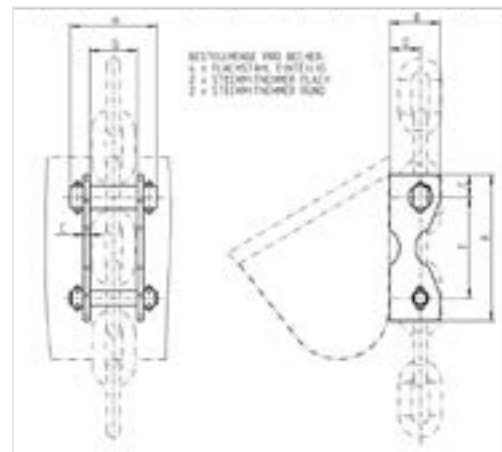

RUD REVERSING WHEEL FOR BUCKET ELEVATORS

SYSTEM 65



REVERSING WHEEL FOR SYSTEM 65 BUCKET ELEVATORS

Properties:

- The bearing ring and the hub plate are stable welded constructions
- Weight-loaded initial tensioning is not required at the deflection due to the interlocked drive. The chain is redirected into uncompressed condition
→reduction in wear

Ordering example:

Pulley block	complete
For chain	30 × 120
Support Ø in mm	980
Dimension C in mm	80
Dimension E in mm	160
Ø Hub bore hole	90 ^{H7}
Chain centre distance	= ...
Flanged wheel distance	= ...

Order numbers

Support Ø G	A	C	E	Weight kg/Piece	Tread	Guide disk	Reversing wheel
540	110	70	140	120	55148	58287	59846
575	100	70	140	125	57571	58153	59847
630	100	70	140	135	57567	58104	59848
730	120	70	140	185	57599	58163	59849
800	120	80	160	210	57615	58204	59851
870	140	80	160	250	57618	58284	59867
980	190	80	160	420	57642	58285	59875
1095	190	80	160	510	57638	58192	59918
1180	195	100	200	620	59810	58280	59929
1280	195	70	140	560	59839	58296	60001

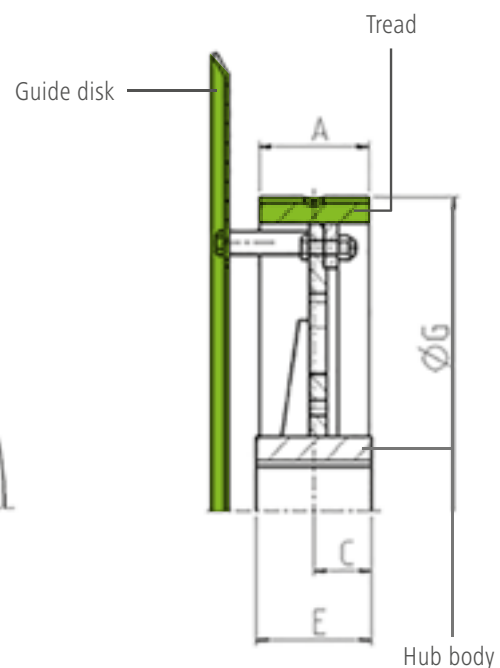
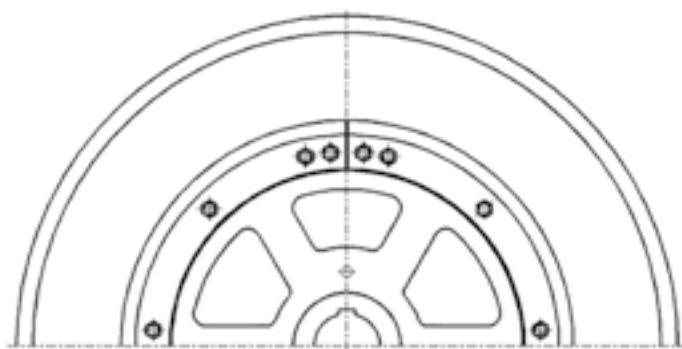

RUD SPROCKET WHEEL

SYSTEM 65

SPROCKET WHEEL WITH REPLACEABLE INDIVIDUAL TEETH ¹

Properties:

- Replaceable individual teeth are made of MnCr special steel
- The teeth are highly wear-resistant
- Surface hardened
- Hub and secondary sheaves are welded construction

Ordering example:

For chain 22 × 86
 Number of teeth 16
 Dimension C in mm 90
 Dimension E in mm 180
 Ø Hub bore hole 180^{H7}

Alternative:

Individual tooth with screw joint
 For chain 22 × 86
 No. of teeth 16

¹ Other dimensions on request

* Preference sizes in accordance with DIN 15251 (shade)

Chain d × t in mm	Teeth	PCD Ø	B	C	E	Weight kg / Piece
14 × 50	16	510	160	50	110	71
	20	637	200	85	170	115
16 × 64	15*	612	200	85	170	125
	17	694	201	75	150	148
	18	734	200	75	150	121
	20	816	210	90	180	148
19 × 75	15*	718	240	75	150	132
	17	813	280	75	150	209
	19	908	270	90	180	289
22 × 86	15*	823	275	90	180	238
	16	878	275	90	180	242
	17	932	270	90	180	299
	18	986	300	100	200	350
26 × 100	14*	894	300	100	200	270
	15	956	300	100	200	290
	16	1020	300	100	200	403
	17	1084	300	100	200	410
30 × 120	14*	1072	300	100	200	409
	15	1148	380	100	200	371
	16	1225	300	100	200	446
	17	1300	325	125	250	501
34 × 136	14*	1214	370	100	200	489
	15	1301	370	100	200	488
	16	1387	390	110	220	677

TEETH WITH INCREASED LINK SUPPORT ALSO AVAILABLE.
 FOR THIS REFER TO PAGE 20.

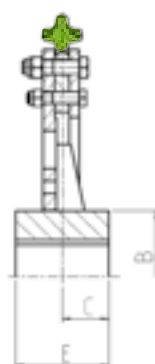
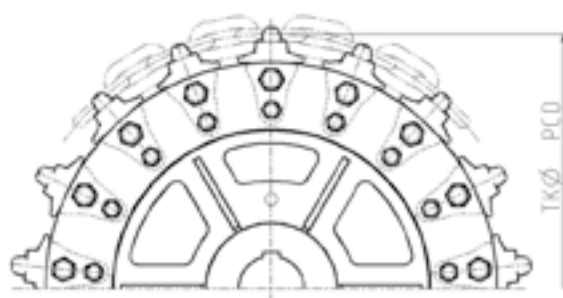

RUD CENTRAL CHAINS

RU50 // RU80 // RU150 // RU200



Components of central chain

The central chain consists of four basic elements, inner plates, bolts, outer plates and bucket attachments.

The chain can be easily opened, shortened or extended by simply bending the chain links at every position without the tool in an assembly- and disassembly-friendly way.

A favourable force distribution and tolerance compensation is achieved using the bolt bearing at the outer plate, which is also carried out in the bushings.

The buckets are mounted using bilaterally stable bucket attachments, which are pushed to the bushings of the outer plates. Increase in the useful life in case of wear of the chain can be achieved once again by turning over the chain.



Properties:

- Hinge points: Bolts float-mounted → high wear volume
- Assembly: without special tool possible
- Standard strand length: 1080 mm packaged in an assembly-friendly way

ASSEMBLY SEQUENCE

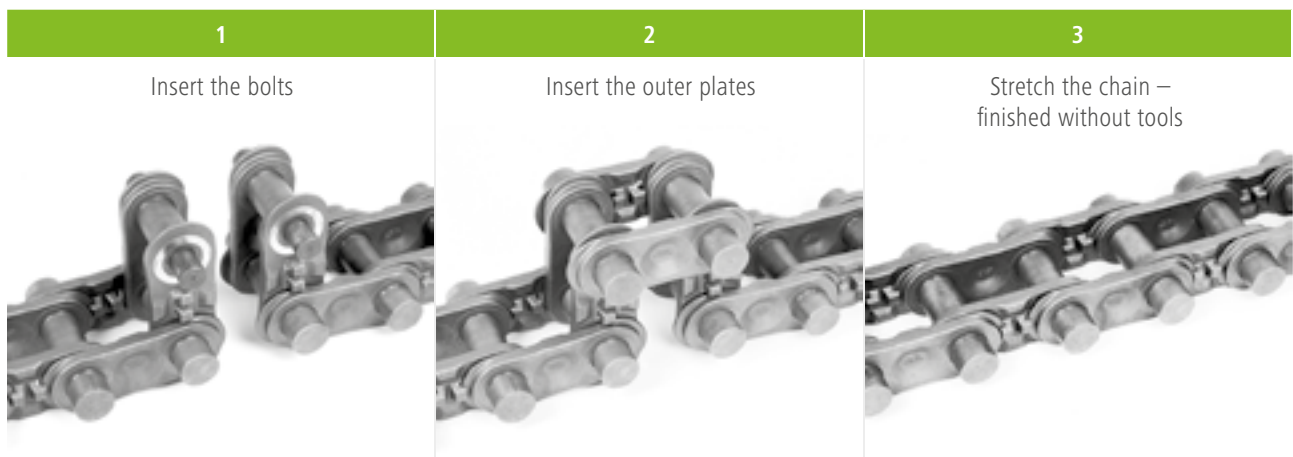



RUD CENTRAL CHAIN

RU50 // RU80 // RU150 // RU200



CENTRAL CHAIN

Order number Chain	Order number Angle	Chain size	Strand length [mm]	Division [mm]	Breaking force [kN]	Possible bucket distance [mm]	Usual bucket width [mm]
7908279	Chain incl. angle	RU50	3408	142	570	568	250–500
7993652	6 × 8904355	RU80	1080	180	800	360/720	400–710
7905523	6 × 8504351	RU150	1080	180	1500	360	400–1000
7992038	Chain incl. angle	RU200	1080	180	2000	360	600–1100



RU50	RU80*	RU150*	RU200*

RUD CENTRAL CHAIN

DRIVE WHEEL // TENSION SPROCKET

DRIVE WHEEL

TENSION SPROCKET

Drive wheel PCD Ø [mm]	Corr. teeth no. of the tension sprocket	B _{max} [mm]	E _{max} [mm]	Weight approx. [kg]	B _{max} [mm]	E _{max} [mm]	Weight approx. [kg]	Usual chain size
645	nontoothed	300	200	172	200	120	127	RU50
700	without gear teeth	300	200	195	200	120	147	RU50
695	12	350	300	380	220	200	230	RU80
800	14	400	360	480	220	200	300	RU80 / RU150
900	15	400	360	570	220	200	360	RU80 / RU150
960	16	370	220	390	220	200	460	RU150
1000	17	400	300	740	220	200	550	RU80 / RU150
1170	20	420	300	880	220	200	700	RU150 / RU200
1300	22	450	300	970	220	200	765	RU150 / RU200

Properties:

- Running threads made of Cr-Mo steel
- Running surface inductively hardened

RUD Drive wheel

Ordering example:

Complete drive wheels for
RUD central chain: **RU80**
PCD: **800 mm**



RUD Tension sprocket

Ordering example:

Complete tension sprocket
For RUD central chain: **RU80**
Number of teeth: **14**

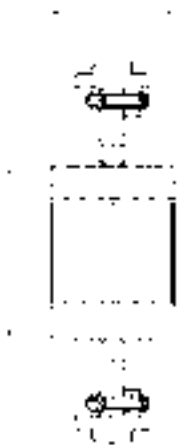

RUD BELT TYPE BUCKET ELEVATORS



Belt type bucket elevator designs using textile or steel reinforced belts transport materials dust-free without difficulty, even to great heights and are especially suitable for the

continuous vertical conveyance of free flowing bulk materials. Suitable adaptations are made to handle coarse-grained or higher temperature materials.

CONVEYING CAPACITIES, REFERENCE VALUES FOR APPROX. 75 % FILLING

Bucket DIN 15233												
	Width [mm]	160	200	250	315	400	500	630	800	1000	1250	1600
	Conveyance speed [m/s]	1.05	1.05	1.15	1.15	1.20	1.20	1.34	1.34	1.48	1.48	1.48
	Conveyance capacity [m³/h]	10	12	25	31	45	63	99	140	224	316	405
Bucket DIN 15234												
	Width [mm]	160	200	250	315	400	500	630	800	1000	1250	1600
	Conveyance speed [m/s]	1.05	1.05	1.15	1.15	1.20	1.20	1.34	1.34	1.48	1.48	1.48
	Conveyance capacity [m³/h]	16	20	38	48	71	101	160	225	348	490	627
Special bucket												
	Width [mm]	160	200	250	315	400	500	630	800	1000	1250	1600
	Conveyance speed [m/s]	1.15	1.15	1.25	1.25	1.28	1.33	1.49	1.49	1.48	1.48	1.48
	Conveyance capacity [m³/h]	25	32	56	70	105	154	246	353	512	726	930
High-capacity bucket conveyor												
	Width [mm]	160	200	250	315	400	500	630	800	1000	1250	1600
	Conveyance speed [m/s]	1.15	1.15	1.25	1.25	1.28	1.33	1.49	1.49	1.48	1.48	1.48
	Conveyance capacity [m³/h]	27	34	64	81	134	198	321	480	652	850	1088

DIMENSIONS

Bucket width	b	160	200	250	315	400	500	630	800	1000	1250	1600
Head	a	724	724	904	904	1004	1160	1264	1460	1673	1747	1747
	c	560	560	695	695	785	885	955	1160	1320	1340	1340
	h	850	850	1050	1050	1250	1450	1600	1800	2100	2300	2300
Funnel	e	1000	1000	1250	1250	1400	1650	1800	2100	2450	2550	2550
	f	280	355	450	545	660	770	900	1110	1300	1600	2000
Foot	a	724	724	904	904	1004	1160	1264	1460	1673	1747	1747
	g	1220	1220	1350	1350	1500	1700	1900	2100	2450	2500	2500
	t	670	670	800	800	880	970	1080	1300	1550	1550	1550
	s	1320	1320	1450	1450	1600	1800	2000	2200	2750	2750	2750
Expansion distance	E	900	1000	1200	1300	1500	1600	1800	2100	2500	2900	3500

RUD BELT TYPE BUCKET ELEVATORS

DESCRIPTION

The bucket elevator casings are selfsupporting, but they require horizontal guides at least every 15 meters and below the elevator head. The bucket elevator head comprises a lower section with doors to access the adjustable discharge plate, and braced bearing mountings, for the pedestal bearings which support the drive shaft, the shaft exit points use grease filled radial shaft seals. The upper sections comprise a multipart removable hood with an inspection door. A drive platform is mounted on the side of the lower part of the head for supporting a wide variety of commercially available drives. If required a maintenance platform and or an overhead support / service beam can be fitted if required. An elevator drive normally consists of a geared motor unit, which is normally connected to a frequency controller for maintenance purposes.

For higher power requirements, we recommend a drive unit with a bevel spur gearbox, and standard motor optionally with ancillary drive. Starting characteristics can be optimized by a hydraulic clutch or an electric soft start.

The double or single leg casing is a torsionally rigid, sheet metal housing constructed of standard section lengths with flange connectors. the maintenance and assembly door position should preferably be located in the elevators raising casing leg, approximately 0.8 m above a platform.

The elevator boot is optionally designed with either internal, oil-filled bearings or external pedestal bearings. With external bearings, the shaft exit points are sealed by gray cast-iron stuffing boxes. There are large assembly doors and cleaning doors on both sides. The belt take-up tension is generated by a parallel weight or spindle take-up device.

Whereas the parallel weight take-up automatically compensates for belt stretch, the spindle take-up requires manual readjustment. The driving pulley has a structured rubber covering. Easy to replace, bolt-on, dished rubberized segments are available upon request.

The take-up pulley is designed as a cage drum. internal cones guide any material that enters the drum out to the sides.

The buckets are manufactured according to din or our works standard. The materials used are steel, stainless steel, aluminum, plastic or rubber. The bucket attachments are selected according to the loads to be handled. Rubber strips are fitted between the belt and the backs of the buckets. The buckets are attached by means of belting bolts, spherical or halfround segments with countersunk bolts. The belts are available with textile or wire-cable reinforcement. Hot-material rubber compounds are used for transporting high-temperature materials. The belt is jointed by mechanical connecting brackets or claw connectors. Belts with a low linear expansion can be continuously vulcanized.

Standard safety devices, comprising off-track governors,

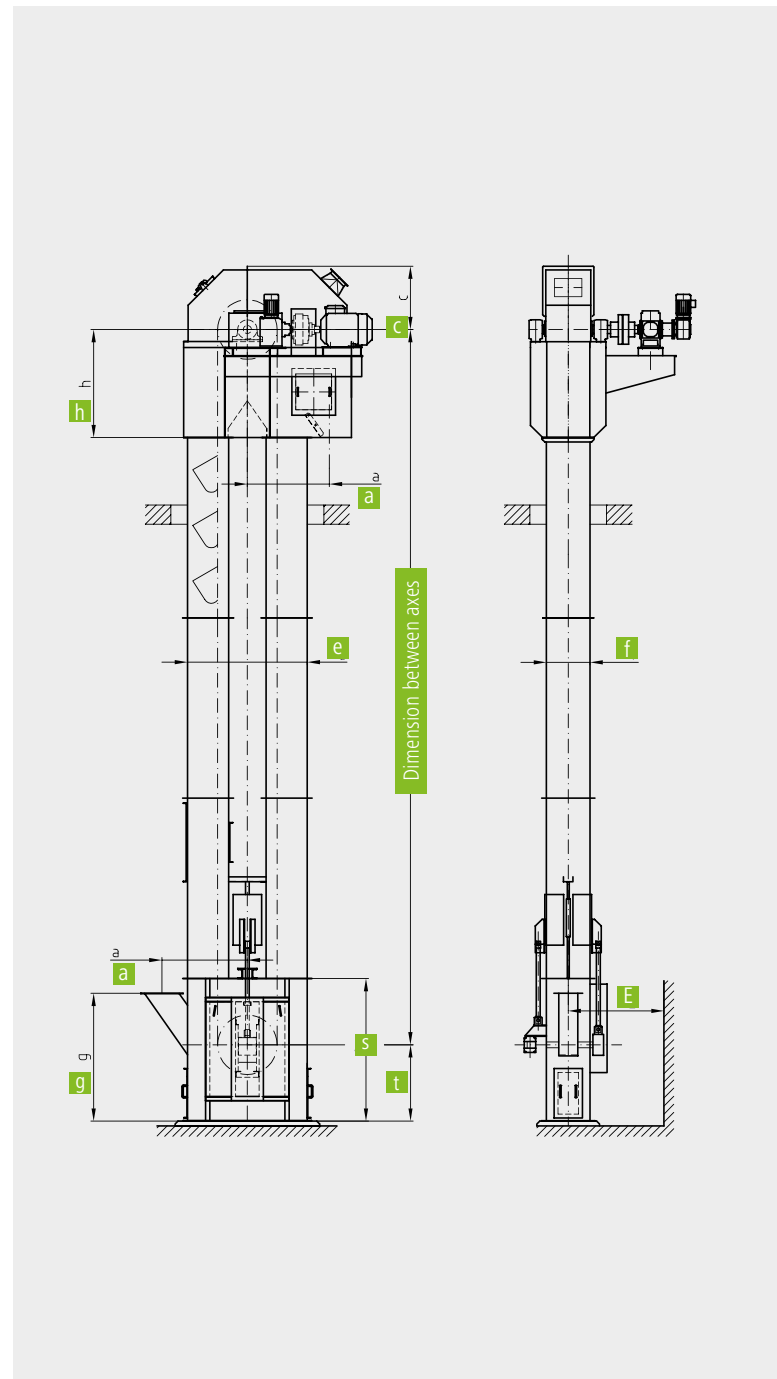

speed governors and level indicators, to monitor the operating status of the bucket elevator are incorporated.

Additional accessories are available. brackets or claw connectors. Belts with a low linear expansion can be continuously vulcanized.

RUD BELT TYPE BUCKET ELEVATORS



THE RUD DRIVE DRUM DESIGN, WITH A CYLINDRICAL CENTRAL SECTION AND Laterally DECREASING DIAMETER, ENSURES

- Uniform load distribution across the width of the belt
- Low wear on the friction lining
- Stable running of the belt and so
- A longer service life for the belt



THE RUD DRIVE DRUM DESIGN WITH INTERCHANGEABLE FRICTION LINING:

- The friction lining is easily exchangeable when worn
- It can be exchanged without removing the drum or opening the belt
- This makes it easier to maintain and so
- Reduces down times
- The segments can be re-used after replacing the rubber



THE RUD PARALLEL TENSION UNIT ENSURES:

- Automatic extension compensation of the belt
- A low pretension force and so low loading
- Stable running of the belt
- A maintenance-free design

RUD

BUCKET ATTACHMENTS // STEEL-CABLE BELTS

RUD STEEL-CABLE BELTS HAVE:

- A tensile strength of 800-3150 n/mm belt width and a low linear elongation of maximally 0.3 %. This means that the belt never needs shortening during its entire service life.
- Steel cross-bracing on both sides to give high transverse rigidity, and so optimal straight running and high tear out strength of the buckets.
- Hot material rubber compositions for conveying material at a continuous temperature of up to 130 °C, and temperature-resistance up to a maximum 10° C peak load.
- 5 mm thick cover plates on both sides and solid rubber edge protection for a long service life, even when handling highly abrasive materials.
- Bucket attachment holes cut by water jet to ensure the highest quality.
- Belt ends prepared in the works for endless connection with mechanical belt connectors. Endless closure can also be achieved by hot vulcanization.



RUD BUCKET ATTACHMENTS:

- Have soft rubber inserts between the backwalls of the buckets and the belt, which prevent the material jamming and reduce the effects of heat on the belt.
- Can optimal adapt to the convexity of the drums.
- Have always the optimal fastening element for the particular load.
- Have extremely high tear-off strength when used with steelrope belts, even in the coarse grain range.

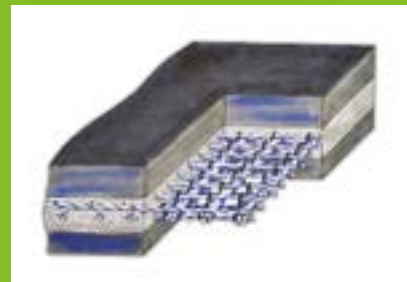

RUD TROUGH CHAIN CONVEYOR

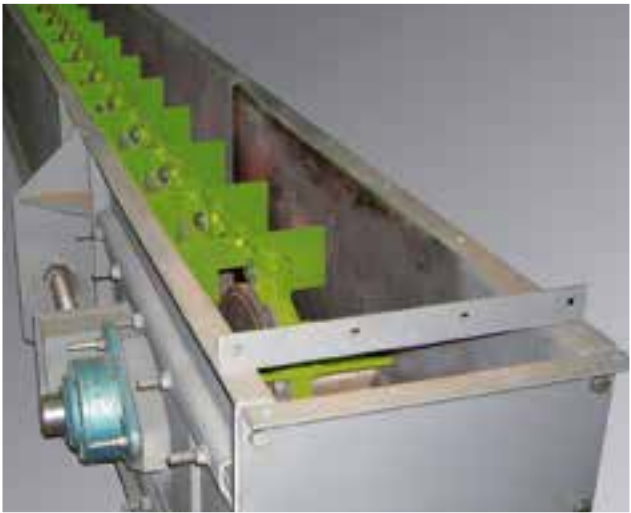

The drive station has flange or pedestal bearings for the drive shaft, depending on the size. Sealing is provided by grease filled, double radial shaft seals. The entire drive station together with the inspection door can be dismantled for easy maintenance. The drive consists of a standard geared motor unit mounted on the bracket attached to the side. Suitable safety clutches can be provided to prevent overloads.

The trough consists of individual, standard-length sections with connecting flanges. Hold-down rails are recommended for most of the materials to be conveyed. These prevent the material from building up and thus the chain climbing. For moderately abrasive materials, the side walls and base plate are protected by manganese alloy steel against wear. Fusion-cast basalt linings or liner plates with hard surface welding are recommended for use with highly abrasive materials. In special cases, the trough floor can be designed to act as a material pad.

The take-up station has flange bearings to hold the take-up shaft. The shaft exit points in the housing are equipped with grease filled, double radial shaft seals. The entire station together with the inspection door can be dismantled for easy

maintenance. The chain take-up is generated and set by spring-loaded pressure screws.

The driving and return sprockets are highly wear-resistant and have interchangeable, hardened toothed segments.

The standard conveyor chains used are forged, fork-sprocket chains that have been heat-treated or case-hardened.

The resistance to wear can be further increased by hard surface welding. Available options are: highly wear-resistant RUD round steel chains, bushed transporting chains according to DIN 8165 and block chains.

Standard safety devices, comprising speed governors and take-up screw monitors, detect the operating status of the trough chain conveyor.

Additional accessories are available.



RUD FORKED-LINK CHAINS

SINGLE // DOUBLE STRAND

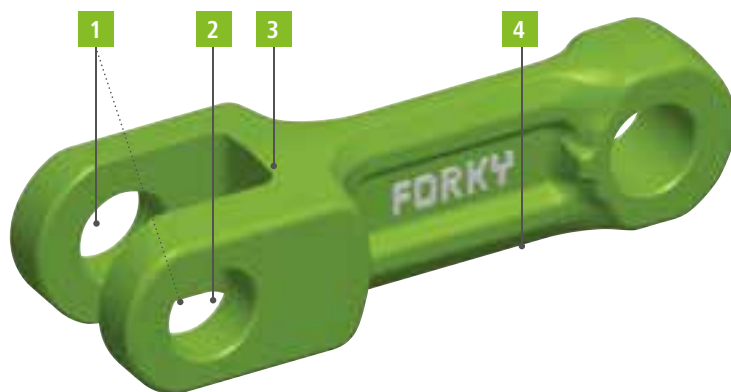

1
Bores parallel to the axle with higher graduation accuracy
 · For smoother running and hence
 · For minimum wear

2
Deburred bores
 · Even inside the fork for highest endurance strength and reliability

3
Extra large radii
 · For more stability of the fork

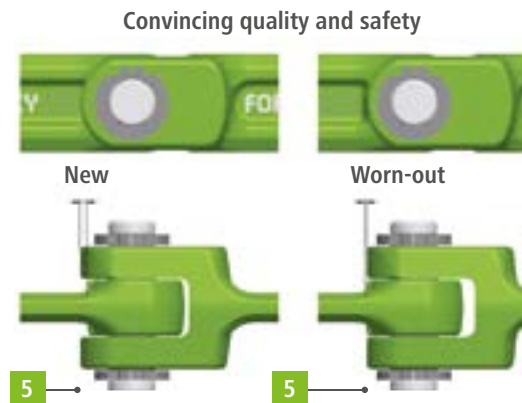

4
Tensioning-optimised bar form
 · For high lateral stiffness

5
Optical wear indicator
 · The wear condition can be recorded at a glance at every individual chain link

FORKY – SINGLE STRAND

Size	Breaking force*[kN]	T [mm]	H [mm]	B [mm]	B _g [mm]	B _n [mm]	S [mm]	D [mm]
142 × 50 × 19	300	142	50	19	42	20	13	25
142 × 50 × 29	480	142	50	29	62.5	30	15	25
260 × 75 × 31	700	260	75	31	70	32	18	32

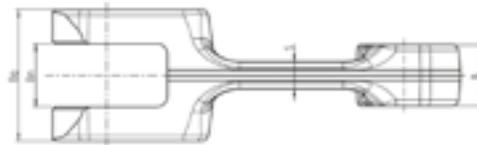
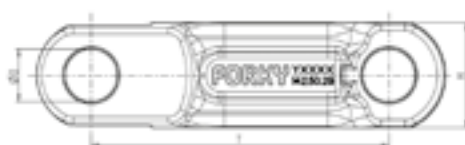

FORKY – DOUBLE STRAND

Size	Breaking force*[kN]	T [mm]	H [mm]	B [mm]	B _g [mm]	B _n [mm]	S [mm]	D [mm]	N [mm]
142 × 50 × 19	300	142	50	19	42	20	13	25	12.5
142 × 50 × 29	480	142	50	29	62.5	30	15	25	12.5
200 × 50 × 25	350	200	50	25	58	26	17	25	12.5
250 × 60 × 30	520	250	60	30	70	31	20	30	12.5

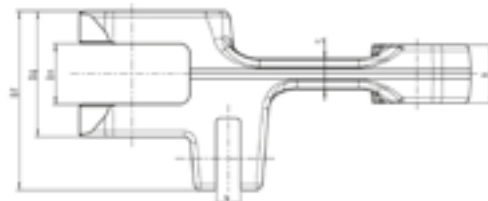
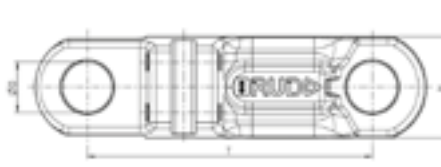

* Theoretical value for case-hardened forking-link chains

RUD ATTACHMENTS COMPONENTES

WHEELS // SPROCKETS

Attachments for single strand forked-link chains FORKY – types of attachments*



Attachments classification



Attachments for double strand forked-link chains FORKY – types of attachments*



Attachments classification



* All the attachment types can also be delivered with welded plates as per your specification! All types on request!

Forked-link chains are suitable for transporting powdered, flaky, grainy and fragmentary bulk materials, but not for sticky or baking bulk materials.

Examples:

Flour, cement, grains, sugar, chemicals, chipped wood, chips, foodstuff, animal feed etc.

Advantages:

- Simple and robust construction, high operational safety
- Lower space requirement
- Horizontal, inclined and vertical conveyor possible
- Explosion safety through slow conveyance without recirculating the material

Disadvantages:

- Limitation of use regarding suitable conveyance materials
- No chunky, fibrous or sticky bulk materials

Drive wheels for forked-link chain

FORKY

Properties:

- Multi-part design
- Tooth flanks inductively hardened
- The sprocket elements can be swapped at the hubs fitted



Reversion wheels for forked-link chain

FORKY

Properties:

- Single-part design
- Contact surface inductively hardened



RUD TROUGH CHAIN CONVEYOR

WITH RUD FORK LINK CHAIN FORKY

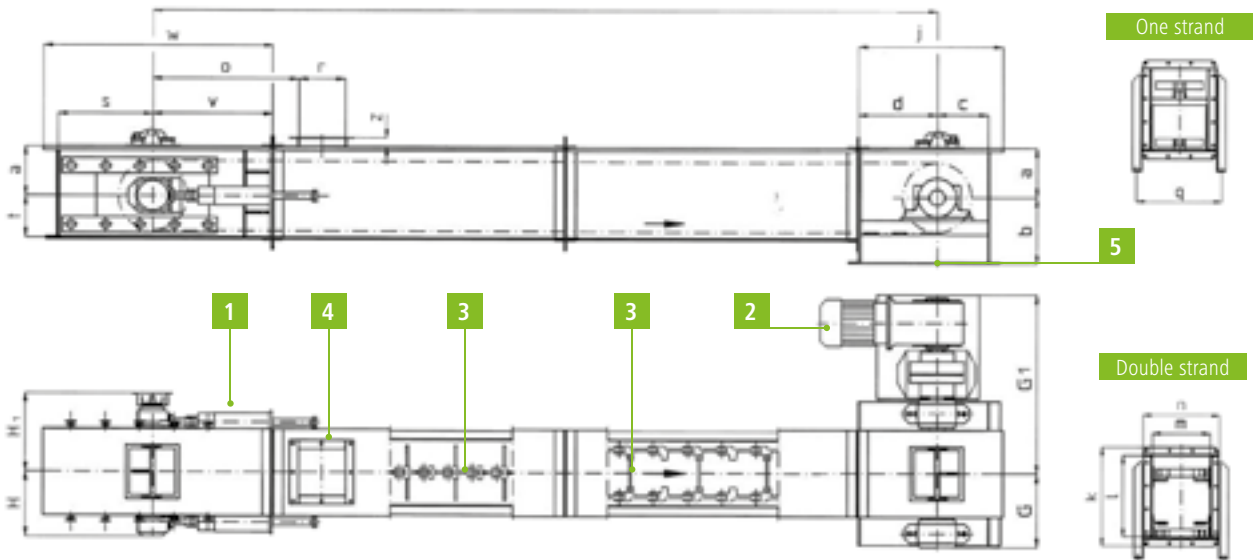

Trough chain conveyor

- 1 Tensioning Station
- 2 Drive station
- 3 Conveyor chains
- 4 Feeding
- 5 Discharge

AVAILABLE TYPES:

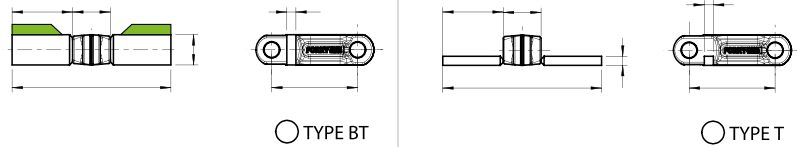

Type T for horizontal and low ascending transport max 10°

Type BT for horizontal and low ascending transport, dusty, free flowing material

■ Type BT special (height up to 1,75 × fork link height), also for high ascending transport max 30°

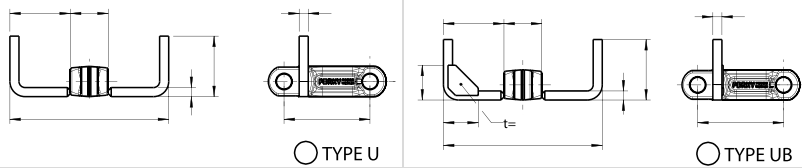

Type U and UB (UB is custom-made) for high ascending transport, 10° up to 25°

Type C and CB (CB is custom-made) for high ascending transport and dusty material, 10° up to 25°

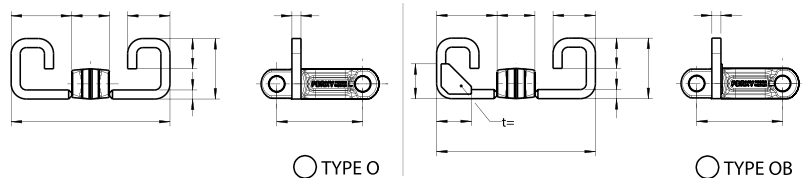

Type O and OB (OB is custom-made) for very high ascending transport, 25° up to 90°

Type C, CB, O and OB primarily for vertical transport



RUD TROUGH CHAIN CONVEYOR

WITH RUD FORK LINK CHAIN FORKY



APPLICATIONS FOR RUD FORK LINK CHAINS:

Condition of conveyed goods:

RUD fork link chains are ideally suited for transporting powdery, grainy, flaky, dusty or fragmentary material

Application:

Construction-, wood-, paper-, plastic-, food and feed industry, chemical industry, mills, port cargo handling, agriculture and recycling industry

Examples of transported material:

Cement, clinker, ash, wood chips, wood shavings, food and animal feed, recycled municipal waste fertilizer, gypsum, coke

CONVEYING SPEEDS [M/S] (MAX. VALUES)

Material	Speed
Grain	1.10
Granulated material	0.80
Coal, chips, soda	0.50
Cement, phosphate, gypsum	0.25
Clinker, petrol coke, potash	0.20
Filter dust, pyrite	0.10
Ash, coke, sand, quartz	0.05

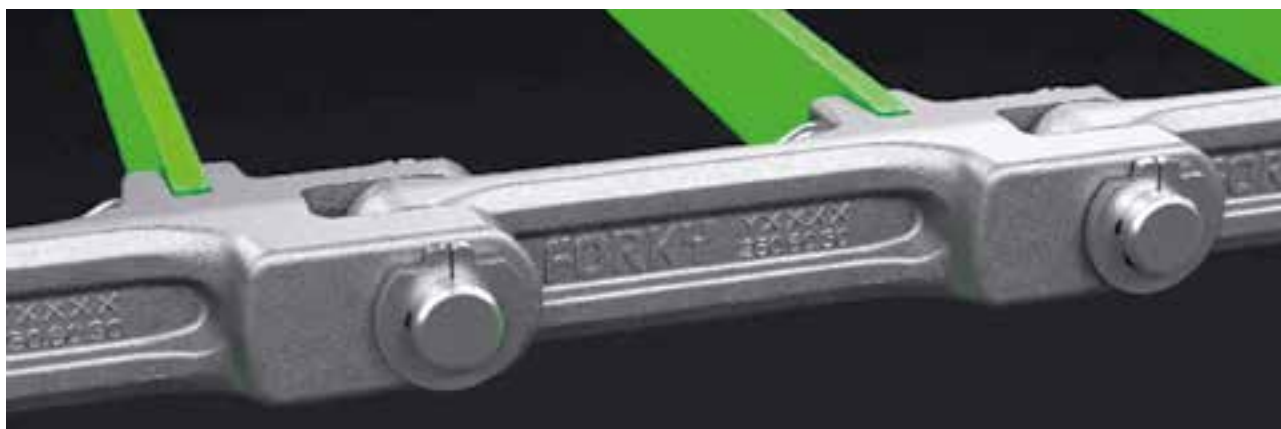

RUD SCREW CONVEYOR

TROUGH SCREW CONVEYOR // TUBULAR SCREW CONVEYOR

Long-lasting, easy to maintain screw conveyors are used for the dust-free, horizontal, inclined and vertical transport of finegrained and floury materials. Suitable adaptations are made to handle coarse-grained, higher temperature, abrasive or poorly flowing materials. Screw conveyors also offer the option of multiple inlets and outlets. Various versions handle not only the transport of bulk materials but also emptying, metering, loading, screening and mixing.

TROUGH SCREW CONVEYOR

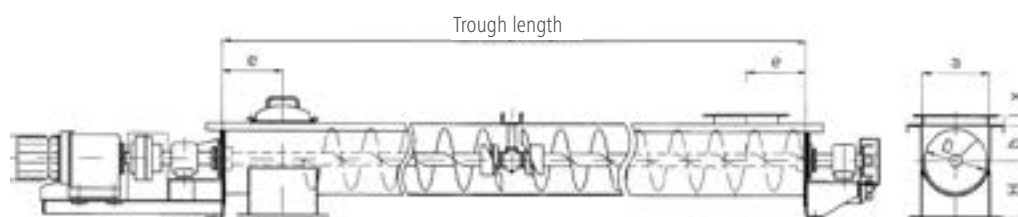

Conveying capacities for horizontal conveyors, reference values for approx. 35% filling

Diameter [mm]	D	200	250	315	400	500	630	800	1000	1250
Speed	[U/min]	100	90	80	71	63	50	40	32	25
Conveyance capacity	[m ³ /h]	9	17	34	59	93	136	195	281	393

Dimensions

Diameter [mm]	D	200	250	315	400	500	630	800	1000	1250
Trough	a	220	270	335	425	525	660	830	1040	1290
	h	112	140	180	224	280	355	450	560	710
	x	52	52	52	53	53	63	74	74	84
	H	190	225	265	315	375	450	560	670	800
	e	200	240	280	330	390	470	560	680	820

TUBULAR SCREW CONVEYOR

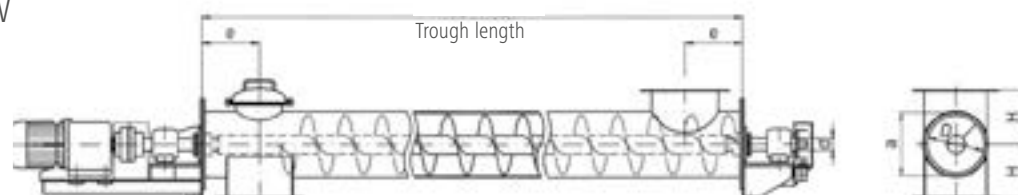

Conveying capacities for horizontal conveyors, reference values for approx. 50% filling

Diameter [mm]	D	140	190	240	290	370	470	570
Speed	[U/min]	112	100	90	80	71	63	50
Conveyance capacity	[m ³ /h]	5	13	23	45	81	131	195

Dimensions

Diameter [mm]	D	140	190	240	290	370	470	570
Tube-shaped trough	a	160.3	210.1	263	312.7	393.8	495.4	595.4
	h	160	190	225	265	315	375	450
	e	170	200	240	280	330	390	470

RUD SCREW CONVEYOR



The conveyor trough in trough screw conveyors is manufactured as a torsionally rigid sheet metal housing made of standard section lengths with connecting flanges, to which are bolted sturdy cover plates, there is also an inspection door above the outlet. Abrasive materials can be handled by using manganese alloy steel, hard surface welding, fusioncast basalt linings or material padding. Split end walls are bolted to the ends of the trough. This makes it easy to dismount the screw shaft once the metal cover plates have been removed.

The conveyor trough in tubular screw conveyors consists of a stable tube with an inspection door above the outlet. One-piece end walls are bolted to the ends of the trough. These are suitable for supporting the conveyor. Intermediate supports are only required about every 6 meters. They are supplied loose for mounting during assembly. The shaft exit points are usually sealed by gray cast iron stuffing boxes.

The screw shaft is designed as a solid shaft or a rigid tubular shaft with integrated end journals and a welded-on screw thread. The end bearings are pedestal bearings with antif-

friction-bearing inserts. When a screw shaft requires intermediate bearings for longer conveying distances. These are designed as easily replaceable units, the torque is transmitted by bolted couplings.

We supply a plain bearing as standard with replaceable twopart, gray cast iron bearing shells. They can be set up for grease gun or central lubrication according to the operational conditions. On request, we also supply antifriction bearings with split roller bearings in a sealed, grease-filled suspended housing. The drive comprises a standard geared motor unit.

As a safety device, a speed governor detects the operational status of the screw conveyor.

Additional accessories are available.



GENERAL INSTRUCTIONS

INSTALLATION AND OPERATION

The adjustability of the deflection should at least be 3 link divisions (compensation of the setting process when running the chain or when chain abrasion takes place).

The usable tensioning distance should be determined after taking into account the length of the loop and the aggressive strain, which affects the chain. Securing the round link steel chains against excess strain or getting blocked by coarse or foreign bodies by means of suitable safety coupling, shear pin or on the drive.

When assembling the sprocket wheels or pulley blocks as well as when manufacturing buckets / bucket attachment and when attaching insertion rails at the return station, accurate adherence to installation dimension and tolerances specified in the respective installation drawings is the prerequisite of proper functioning.

Adhere to the constant initial tension using springs or weights in adjustable tensioning devices, where the size of the chain pre-tensioning force must be coordinated as per the specifications of the respective conveyor. During their complete service life, the chains must be under the correct initial tension. Loose chains give rise to difficulties.

During all the system constructions, the corresponding accident prevention regulations must be considered.

The bulk material to be transported must be supplied in such a way that equal distribution is ensured across the width of the buckets / scraper bar width and all the chain loops are equally tensioned through the bulk material and the tractive force. In case of lateral feed, corresponding precautions must be taken.

Unequal loop stress leads to unequal increase in division due to the wear of individual chain loops; this results in the slanting of the buckets / scraper bars, which in turn results to faults at the return station.

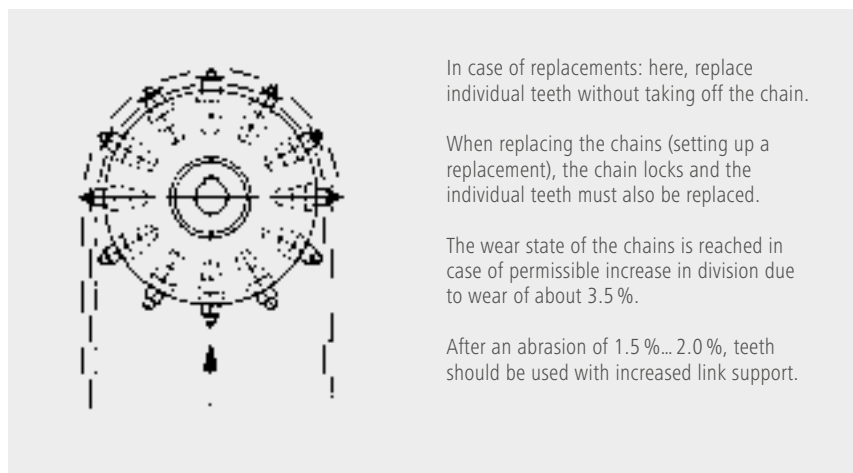
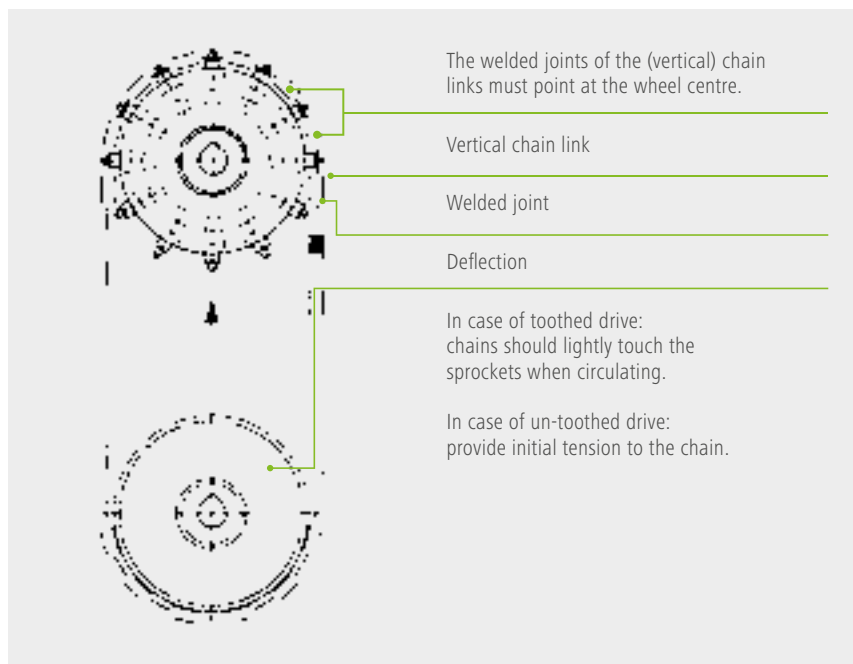
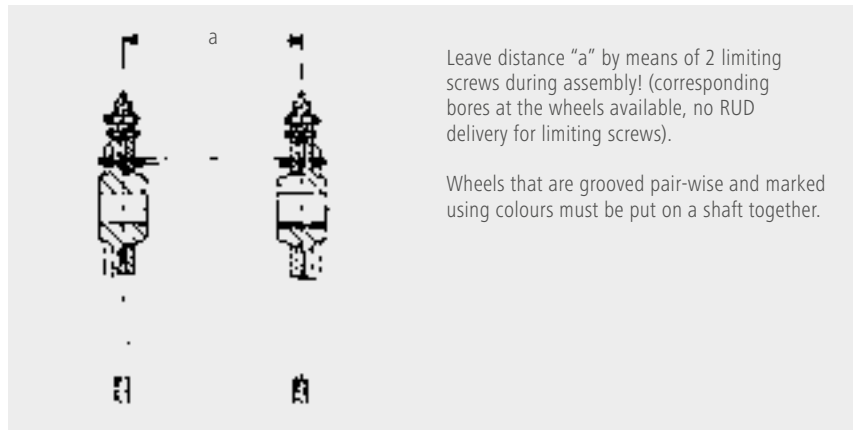

MAINTENANCE & MONITORING ASSEMBLY INSTRUCTIONS

OF CONVEYOR SYSTEMS IN RUD SYSTEM

RUD conveyor chains – highly wear-resistant– are hard-wearing due to their simple structure assembly and hence require very little maintenance. The following points must be observed with regard to high operational safety:

Lubrication: RUD conveyor chains – highly wear-resistant – do not normally require lubrication. Such chains may however be lubricated with standard engine oil (not grease), which do not come in contact with the bulk material or aggressive dusts etc. and hence formation of lubrication gel paste in the joints cannot be safely ruled out. Dirty chains should be cleaned before re-lubrication.

Initial tension: The chain tensioning must be checked periodically, especially during the start-up phase of new chains and/or in case of large loop lengths. It must be tensioned only to the extent necessary for the proper functioning of the chain and carriers during normal operating conditions. In case of multi-belt conveyors, the initial tensioning force of all the chain loops must be equal. Unnecessary high initial tensioning force reduces the service life.

Monitoring: Chains, locks, wheels, sprockets and flange parts must be checked at periodic intervals for damages, corrosion and unusual wearing parts, and the conveyor elements for deflection and the like. While doing so, attention must be paid to the state of the wearing and safety parts. Damages detected must be immediately rectified.

Wear: Round link steel chains and wheel gearing wear out together up to the wear state under normal conditions. This is reached if the chain links at the driving gear run jerkily under stress due to the abrasion to the chain and simultaneous normal chain tensioning or come off suddenly, i.e. are coves off over the normal break-off point. If the distances between the axis is large, the bulk material is heavily worn out or corroded, in case of high speed, heat influence etc., the chain can run jerkily at the driving gear although the measured increased division due to abrasion is still less than approximately 1.5 %. in this case, the wheel gearing is worn out due to the especially high stress and only this must be replaced - but simultaneously at all the driving gears. In principle, the new round link steel chains must only be used along with the new wheel gearing. Round link steel chains, whose average link thickness at any location has reduced by more than 10 % of the nominal thickness, must be removed. (average link thickness = mean of 2 dimensions taken perpendicular to each other at the maximum weakened cross-section).

In case of necessary chain reductions, level links must be cut out at the belts to be shortened. Shorten chain belts to odd number of links only, in order to get level starting and final links. The chain links must be carefully cut using cutting discs and without damaging the neighbouring links. Avoid heat influences on links not affected by the cutting at all costs.

Welding works: In principle, welding processes should not be carried out at the round link steel chains, chain locks or deeply case-hardened components. It is not permissible to use the chain as earthing connection for electro-welding work at the steel construction.

In case of single and multi-belt conveyors: The welded joints of the chain links at the level of the gear must point at the driving gear; the position of the other links is arbitrary. Make sure that the installation position of the chain locks for the sprocket wheels is correct – coach bolt parallel to the sprocket wheel axis (also applicable for pocket wheels and striation sprockets). Install carefully and tighten the screws (strength class 8.8) using torque spanners. After a specific period, re-tighten the screws once again. Assembly for Fa flat lock: link U brackets, hammer in locking bolts and secure with a locking pin.

Thread dimension	Tightening torque	
	[nM]	[Lbf ft]
M 6	10	7
M 8	25	18
M 10	49	35
M 12	85	62
M 14	135	98
M 16	210	152
M 18	300	217
M 20	425	307
M 22	580	420
M 24	730	528
M 27	1100	796
M 30	1450	1049
M 33	1900	1374
M 36	2450	1772

Permissible screw tightening torques for screw quality class 8.8 with total drive value $\mu_{ges.} = 0.14$.

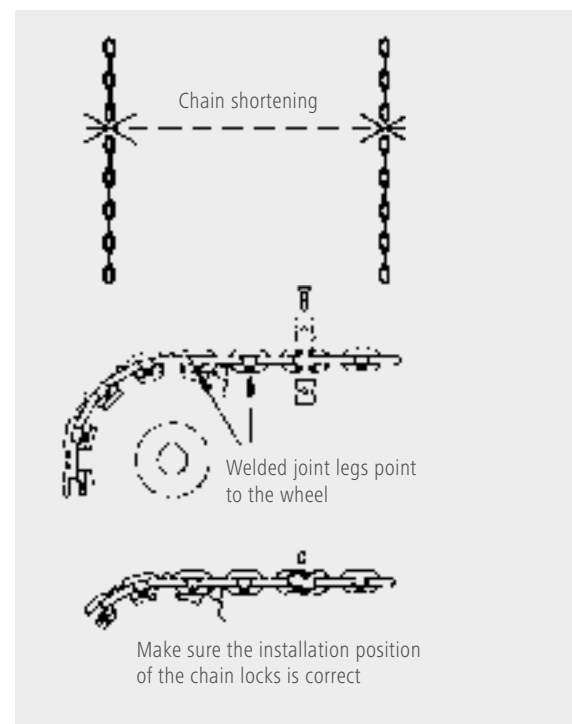

TECHNICAL QUESTIONNAIRE FOR CONVEYOR SYSTEMS

TEL.: +49 (0) 7361 504-1457
 FAX: +49 (0) 7361 504-1523
 CONVEYOR@RUD.COM
 WWW.RUD-CONVEYOR-SYSTEMS.COM

Company: *	Name: *
Road: *	E-Mail: *
Post code: *	Place: *
Telephone: *	Fax:

Project: New construction Reconstruction

Bulk material designation: *

Bulk material bulk density [t/m³]: *

Bulk material properties	Corrosion:	<input type="checkbox"/> high	<input type="checkbox"/> medium	<input type="checkbox"/> none
	Abrasion:	<input type="checkbox"/> high	<input type="checkbox"/> medium	<input type="checkbox"/> none

Granularity/ dimension: mm max. mm min.

Moisture content: Temperature [°C]:

Conveyance capacity max. [t/h]:* Speed [m/s]:

Daily operating hours [h]: Annual operating hours [h]:

Dimension between axes [m]: * Trough width [mm]: * or conveyor width [mm]: *

Conveyor:	Assignment of material to be transported:	Type of conveyor:
<input type="checkbox"/> on lower run	<input type="checkbox"/> regular	<input type="checkbox"/> Ash remover <input type="checkbox"/> Coaling
<input type="checkbox"/> on upper run	<input type="checkbox"/> irregular	<input type="checkbox"/> Trough conveyor <input type="checkbox"/> Bunker discharge

Chain centre distance [mm]: Drive power requirement [kW]:

Chain sprocket diameters [mm]: Max. operating force / chain strand [kN]:

Scraper bars: yes no
 (Scraper bar outline on the following page S. 67)

Line profile: *
 Please add detailed drawing
 with the necessary dimensions!

Profile examples:

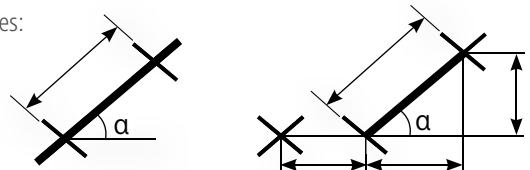

Additional specifications / Additions: _____

Annexes / Drawings / Pictures: _____

SKETCHES

FOR SCRAPER BARS

Clear through width of the conveyor [mm]: _____

Chain centre distance [mm]: _____

Through bottom material _____

Granite/Basalt

Hardox

Wearing rails

Additional information / additions to questionnaire conveyors (Page 66)

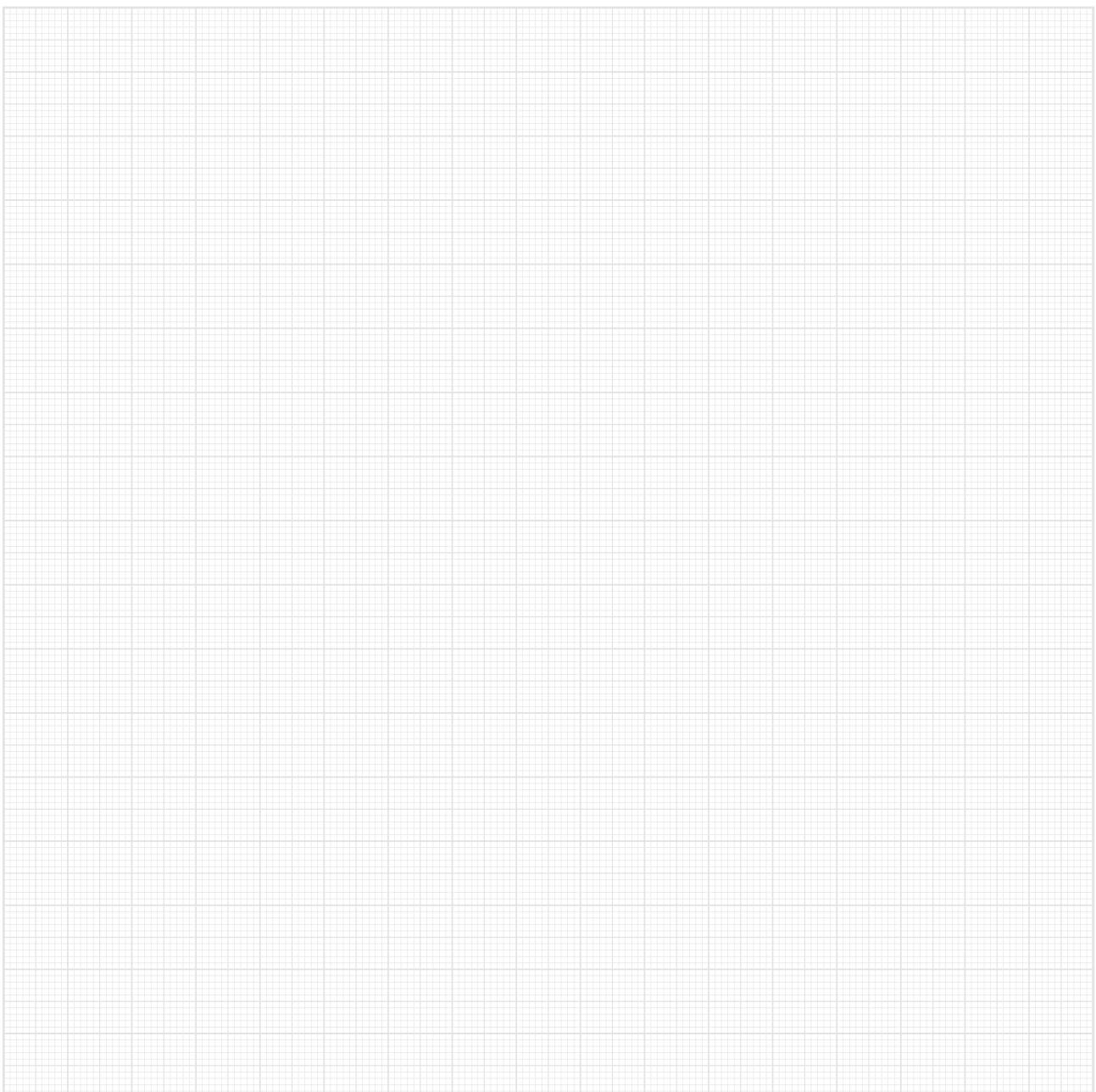

SOI 1/2

DIMENSION SHEET

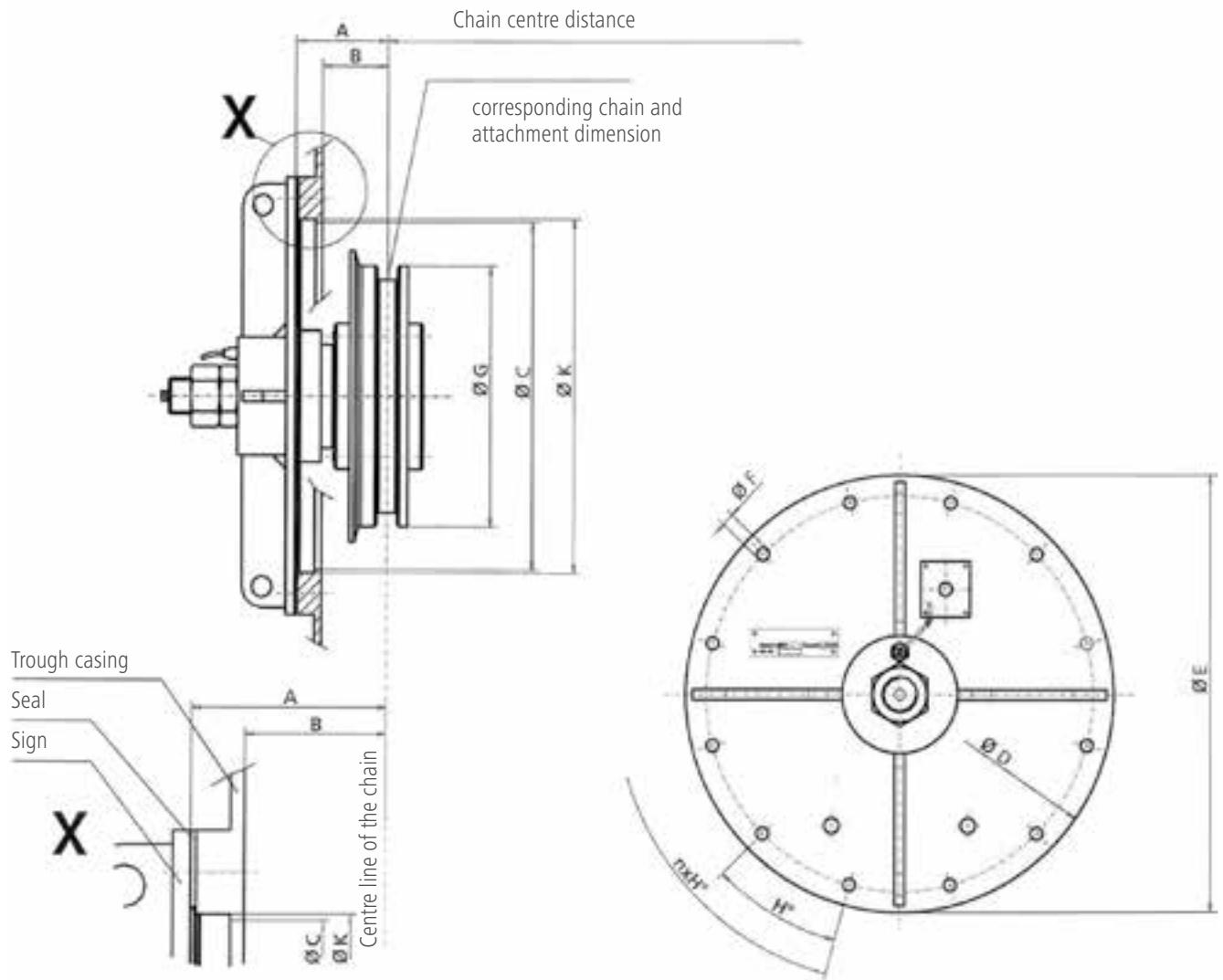

Connecting and functional dimensions

	Dimension mm	n (number of bores in the plate):
A		
B		
Ø C		Chain type and dimension:
Ø D		
Ø E		
Ø F		Attachment type and dimension:
Ø G		
H°		
Ø K		

TECHNICAL QUESTIONNAIRE FOR CONVEYOR SYSTEMS

TEL.: +49 (0) 7361 504-1457
 FAX: +49 (0) 7361 504-1523
 CONVEYOR@RUD.COM
 WWW.RUD-CONVEYOR-SYSTEMS.COM

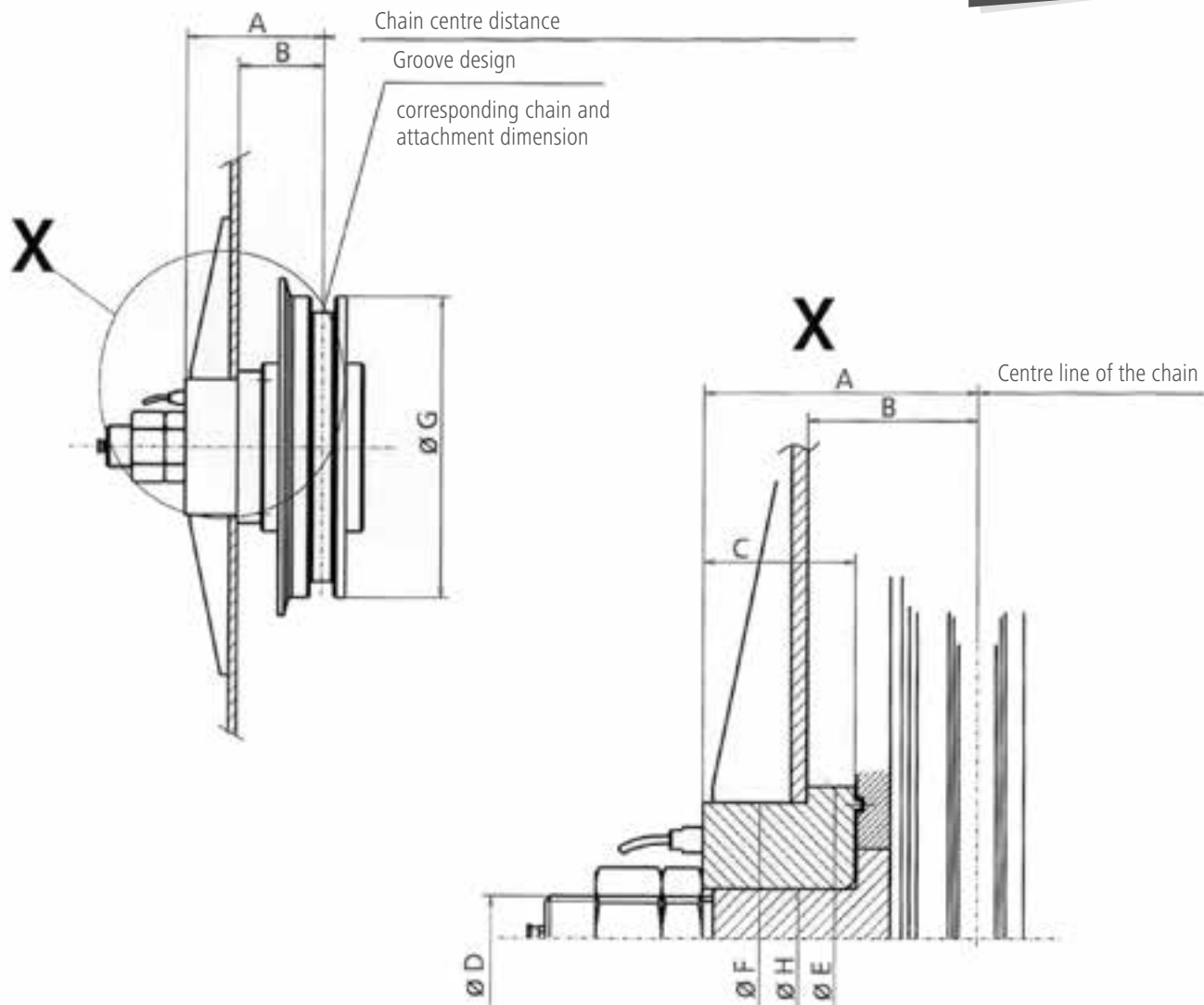

Connecting and functional dimensions

Dimension mm	Chain type and dimension:
A	
B	
C	
Ø D	
Ø E	Attachment type and dimension:
Ø F	
Ø G	
Ø H	

REVERSING WHEEL TYPE A-B-C

HUBS / BORE DIMENSIONS

RUD-UMLENKROLLEN-TYP-A-B-C GUIDE WHEEL TYP-A-B-C FOR CRATOS
Naben/Bohrungsmasse Hub bore dimensions

Umlenkrollen Typ Guide Wheel Typ	entspricht Z= no. of teeth	Auflageø supportø	Kette chain	Bohrungsø boreø	Nabenlänge E Dimension E	Teilänge C Dimension C	NUT DIN 6885 Keyway DIN 6885	NUT DIN 6886 von innen nach aussen	Keyway DIN 6886 von aussen zu innen
Typ=									
Angebots-Nummer: Auftrags-Nummer: offer number: order-number:		Freigabe - Bestätigung des Kunden: release-customer-confirmation:			Datum: Unterschrift: date: signature:		001-F80885-PO7		

COPYRIGHT RESERVED
SCHUTZRECHT NACH DIN ISO 10303 BEWAHRTEN AUFTRAG ZIEHRUNG DAMF NUR IN CAD-SYSTEM GEÄNDERTE VERSION

Sprocket wheel single-part:

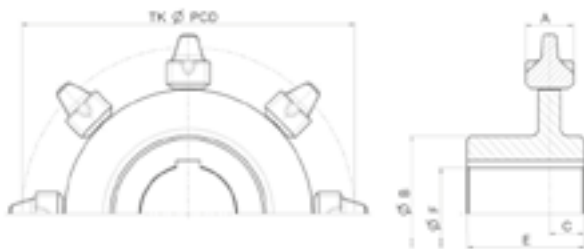

Sprocket wheel multi-part:

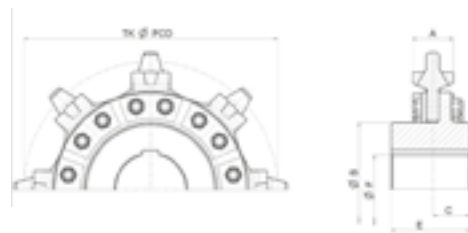

Ordering example:

Sprocket wheel	Single part / Multi-part	Dimension C	...mm
For chain	19 × 75	Dimension E	...mm
Number of teeth	8	Number of pieces	10
Hole-ø	...mm	Other dimensions	on request.

TECHNICAL QUESTIONNAIRE FOR

BUCKET ELEVATOR & COMPONENTS

BUCKET CONVEYORS:
 TEL.: +49 (0) 531 23 729-14
 FAX: +49 (0) 531 23 729-10
 VERTRIEB@HERFURTH-ENGELKE.DE

COMPONENTS:
 TEL.: +49 (0) 7361 504-1457
 FAX: +49 (0) 7361 504-1523
 CONVEYOR@RUD.COM

Company: * _____ Name: * _____

Road: * _____ E-Mail: * _____

Post Code: * _____ Place: * _____

Telephone: * _____ Fax: _____

Project: _____ New construction Reconstruction

Bulk material designation: * _____

Bulk material bulk density [kg/dm³]: * _____

Granularity / dimension: _____ mm max. _____ mm min.

Moisture content: _____ Temperature [°C]: _____

Conveyance capacity max. [t/h]: * _____ Speed [m/s]: _____

Daily operating hours [h]: _____ Annual operating hours [h]: _____

Dimension between axes [m]: * _____ Mounting of buckets: * shouldered lateral

Bucket designation: * _____

Bucket content [l]: * _____ Bucket weight [kg]: * _____

Axle drive shaft rotation [U/min]: _____ Diameter drive shaft [mm]: _____

Diameter of sprocket wheels [mm]: _____ Diameter expansion shaft [mm]: _____

Please add the drawing of the bucket conveyor and the bucket.

Bucket attachment:



- RUca System „65“ System „2win“ System „SWA“ „Central Chain“ System
 other bucket attachment (e. g. DIN)

Supplier / Manufacture actual chain: _____

Bucket specification
 (please add the dimensioning)

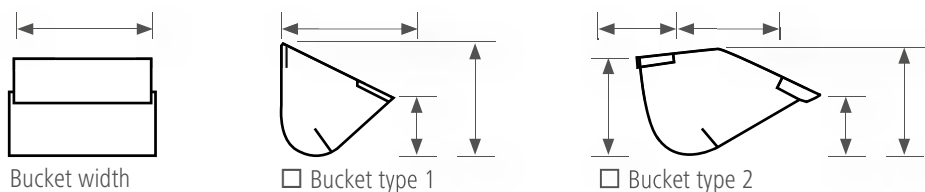

Casing dimension:
 (please add the dimensioning)

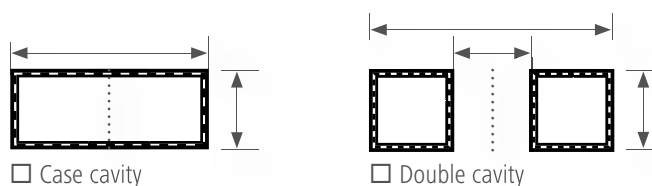

Additional specifications /
 drawings / pictures / additions
 (f. e. customer issues, target,
 project, extended settings)

TECHNICAL QUESTIONNAIRE FOR

TROUGH CHAIN CONVEYOR / SCREW CONVEYOR

TEL.: +49 (0) 531 23 729-14
FAX: +49 (0) 531 23 729-10
VERTRIEB@HERFURTH-ENGELKE.DE

Company: * _____ Name: * _____
Road: * _____ E-Mail: * _____
Post code: * _____ Place: * _____
Telephone: * _____ Fax: * _____

Project: _____

Material to be transported: _____

Bulk material properties: _____

Corrosion: high medium none

Abrasion: high medium none

Granularity / dimension: _____ mm

Speed [t/m³]: _____ Temperature [°C]: _____

Moisture content: _____ Requested conveyance capacity [t/h]: _____

Conveyance speed [m/s]: _____

Total daily service life: _____ Per year [h]: _____

Dimension between axes [m]: _____ Angle of gradient [degree]: _____

Trough width [mm]: _____

Conveyor on lower run _____ Conveyor on upper run _____

Assignment of material to be transported? Regular: _____ Irregular: _____

a) Line profile with specification of the location of the bulk material task and removal
with dimension specification

b) Bunker discharge (attach the dimensioned drawing)

Chain sprocket diameters [mm]: _____

Drive power requirement [kW]: _____

Max. operating force per chain strands [kN]: _____

New construction Reconstruction (specify available casing dimension)

In case of special requirements, please enclose a specification or a sketch.

TECHNICAL QUESTIONNAIRE FOR

FORKED-LINK CHAINS

TEL.: +49 (0) 7361 504-1457
 FAX: +49 (0) 7361 504-1523
 CONVEYOR@RUD.COM
 WWW.RUD-CONVEYOR-SYSTEMS.COM

Single strand

Verschiedene Arten der Verbindung
Different types of the connection

Variante A (Type A)
 Variante B (Sondervariante) (Type B (Special design))

Bolzen Pin
 Kopfbolzen Head pin
 Schließring Locking ring (Circlip)
 Spannstift Locking pin
 Stellring Adjusting ring

Mitnehmer an jedem Glied (Attachment at every link)
 Mitnehmer an jedem 2. Glied (Attachment at every 2nd. link)
 Mitnehmer an jedem 3. Glied (Attachment at every 3rd. link)
 Mitnehmer an jedem ___ten Glied (Attachment at every ___ link)

TYPE BT
 TYPE T
 TYPE U
 TYPE UB
 TYPE C
 TYPE CB
 TYPE O
 TYPE OB

Double strand

Verschiedene Arten der Verbindung
Different types of the connection

Variante A (Type A)
 Variante B (Sondervariante) (Type B (Special design))
 Variante C (Sondervariante) (Type C (Special design))

Bolzen Pin
 Schließring Locking ring (Circlip)
 Kopfbolzen Head pin
 Spannstift Locking pin
 Stellring Adjusting ring
 Haltestift Fixing pin

Mitnehmer an jedem Glied (Attachment at every link)
 Mitnehmer an jedem 2. Glied (Attachment at every 2nd. link)
 Mitnehmer an jedem 3. Glied (Attachment at every 3rd. link)
 Mitnehmer an jedem ___ten Glied (Attachment at every ___ link)

TYPE H
 TYPE HB
 TYPE HV
 TYPE HW

L profile EN 10056-__X__X
 X 2.5

TECHNICAL QUESTIONNAIRE FOR FORKED-LINK CHAINS

TEL.: +49 (0) 7361 504-1457
FAX: +49 (0) 7361 504-1523
CONVEYOR@RUD.COM
WWW.RUD-CONVEYOR-SYSTEMS.COM

RUD-ANTRIEBSRAD FORKY RUD-DRIVING WHEEL FORKY
Naben/Bohrungsmasse Hub bore dimensions

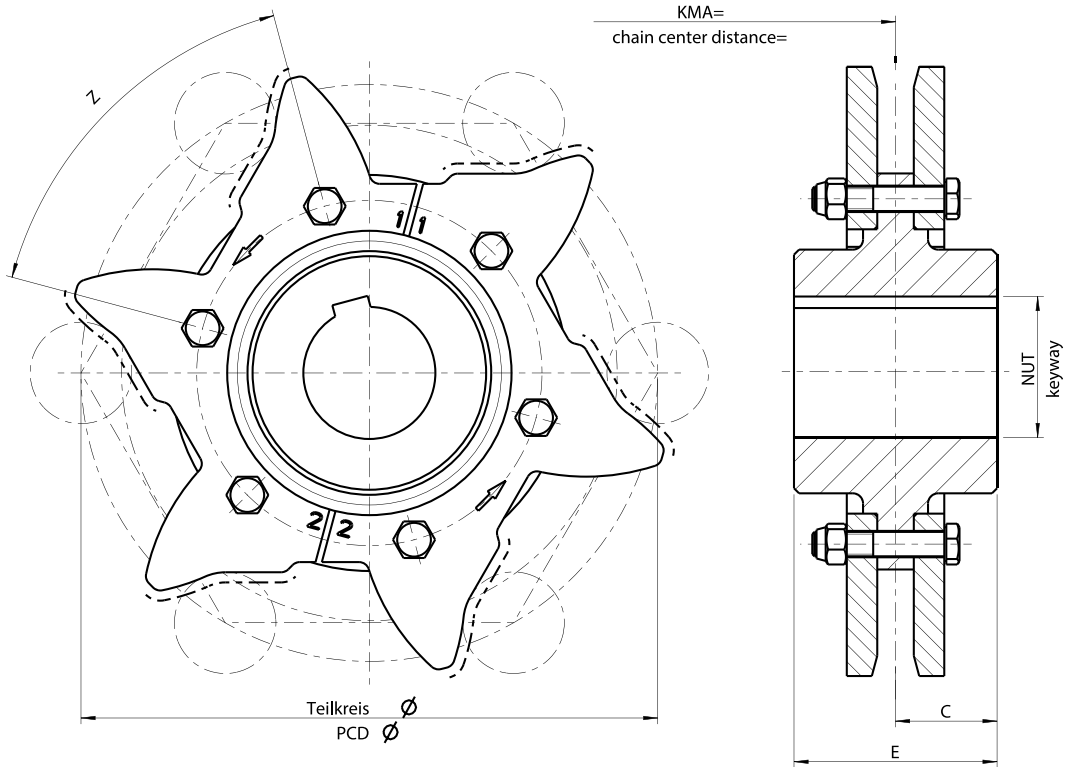

FORKY EINSTRANG/FORKY SINGLE STRAND

FORKY Çift Sıralı /FORKY DOUBLE STRAND

Kama yatağı/keyway
DIN 6885 or 6886

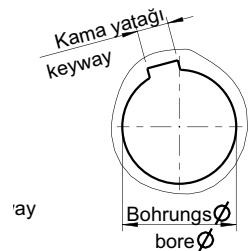
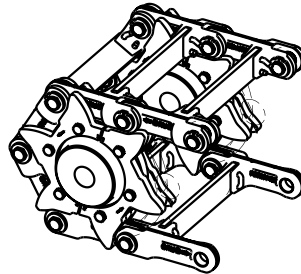
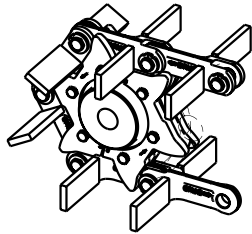

Copyright reserved // Copyright as per DIN ISO 16016 // Attention: please note: drawing may only be changed in the CAD system!

Dişli Çark Sprocket wheel	Diş Sayısı no. of teeth	Bölüm Dairesi Çapı Ø PCD Ø	Kette chain	BohrungsØ boreØ	Nabnlänge E Dimension E	Teillänge C Dimension C	Kama yatağı DIN 6885 Keyway DIN 6885	Kama yatağı DIN 6886 von innen nach aussen	Keyway DIN 6886 from outside to inside	Stellschraube adjusting screw
Angebots-Nummer: Auftrags-Nummer: offer number: order-number:		Freigabe - Bestätigung des Kunden: release-customer-confirmation:			Datum: Unterschrift: date: signature:		erstellt: 12.04.13/JJU geprüft:		FORKY RÄDER/FORKY WHEELS NABEN BOHRUNGSMASSE/HUB BORE DIMENSIONS RUD-CRATOS 001-F80888-P23	
							RUD			

CONVEYOR AND DRIVES

RUD CONVEYOR SYSTEMS

- Sling and lashing system
- Conveyor systems
- Hoisting and drive technology
- Tyre protection chains
- Slide protection chains
- Military technology
- Furnishings

· RUD conveyor and drive systems offer you a variety of system solutions for your case of application. Whether it is conveying, driving or lifting, we shall offer you the suitable system.

· We construct and manufacture bucket conveyors, scraper conveyors and special drive solutions for lifting, conveying or moving preferably by means of round link steel chain as the traction mechanism.

· If required, we also use sprocket chains and belts.

· Our engineers provide an extensive background knowledge and support you as a competent partner for solving your conveyance task.

· If requested, the Rud service can visit you on-site and support you during the installation, reconstruction or maintenance of your system.

· We provide a high competency in conveyor systems of heavy bulk materials in the system construction.

· We solve special problems with our drive and handling technology in the industrial and maritime environment.

Communication medium for other RUD products:

- Sling and lashing system
- Drive technology
- Military technology
- Tyre protection chains
- Lifting chains
- Non-skid chains

Refer to: www.rud.com or tel.: +49 (0) 7361 504-0





RUD Ketten
Rieger & Dietz GmbH u. Co. KG
Friedensinsel
73432 Aalen / Germany
Tel. +49 7361 504-1457 / Fax +49 7361 504-1450
Email: conveyor@rud.com · www.rud.com



CONVEYANCE AND DRIVE TECHNOLOGY



Whether it is complete bucket conveyor, chain conveyors or chain drive, RUD BULKOS rises to every conveyor challenge thanks to our extensive experience with the most varied bulk materials such as cement, fertilisers, stones and soils and many others.



As the technology leader, RUD provides components and total solutions on the basis of round link steel chains and FORKY for energy generation with coal and biomass as well as in the area of recycling. Be it material supply, ash removal or cleaning scraper, RUD CRATOS offers the suitable solution.



RUD is the global original equipment manufacturer among the leading lifting equipment manufacturers. We also offer a variety of round link steel chains for different industries.



The RUD TECDOS team is developing and manufacturing drive solutions for turning, lifting, moving, telescoping or shifting. In addition to the component program, complete solutions are also available as the TECDOS omega and Pi drives.



RUD chain locks "Powerblock" and "dominator" are considered as benchmarks of the industrial sector throughout the world and are used in high-performance mining companies due to their high level of reliability.